

# R&S<sup>®</sup> VENICE S800/824-G3

## User Manual

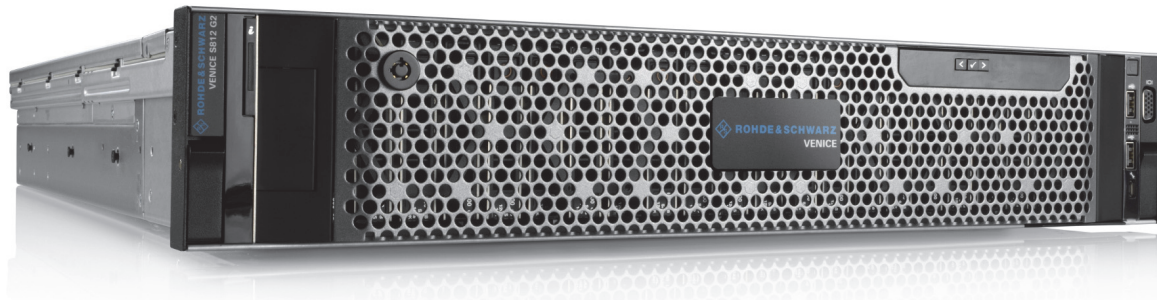

2906.2506.02  
Version 03

**ROHDE & SCHWARZ**  
Make ideas real



© 2023 Rohde & Schwarz GmbH & Co. KG

Hanomaghof 4, 30449 Hanover, Germany

Phone: +49-511-67807-0

Support: <https://www.rohde-schwarz.com/support>

Internet: <https://www.rohde-schwarz.com>

Subject to change – Data without tolerance limits is not binding.

R&S® is a registered trademark of Rohde & Schwarz GmbH & Co. KG.

Trade names are trademarks of the owners.

Throughout this manual, products from Rohde & Schwarz are indicated without the ® symbol, e.g. R&S®VENICE is indicated as R&S VENICE S G3.

# Contents

<b>Safety and regulatory information</b> .....	7
<b>Safety instructions</b> .....	8
<b>Labels on the Product</b> .....	12
<b>Warning Messages in the Documentation</b> .....	13
<b>Where to find key documents on Rohde &amp; Schwarz</b> .....	14
<b>General Notes</b> .....	15
<b>Korea Certification Class A</b> .....	16
<b>Documentation overview</b> .....	17
<b>About this Documentation</b> .....	18
Required Reading .....	18
Additional Documentation .....	18
<b>Product Description</b> .....	19
<b>Function</b> .....	20
<b>Models</b> .....	21
<b>Features</b> .....	22
Channel Configuration .....	22
Workflow-based Metadata .....	23
Audio Routing .....	30
Image Processing .....	30
Timecode .....	31
Play After Write .....	32
<b>Type Plate and Serial Number</b> .....	33
Type Plate .....	33
Serial Number .....	34
<b>Scope of Delivery</b> .....	35
<b>The Front of the System</b> .....	36
<b>The Rear of the System</b> .....	40
Back Panel .....	40
LTC In/Out .....	41
Power Supply Unit .....	42
Out- or Input of Primary/Secondary Control Signals .....	43
Downconvert Video Output .....	43
SDI Sync Ref In .....	44
In-/Output of Digital Video Signals .....	45
Network Interface (NIC) Connectors .....	49
NIC Indicator .....	49
<b>Inside the System</b> .....	51
System Cover .....	51
Cooling Fan Assembly .....	52
Cooling Fans .....	53
Rescue Stick .....	54
<b>Pin Assignment</b> .....	55
HD Sub-D Connector (LTC In/Out) .....	55
RJ45 Connector .....	56
Video Connector .....	57
Lynx CBL-AES1604 Cable .....	59

<b>Network Ports</b> .....	<b>60</b>
VENICE S Server Ports (Information) .....	60
VENICE S Server Ports (Configuration) .....	64
VENICE S Client Ports (Information) .....	66
VENICE S Client Ports (Configuration) .....	68
<b>Installation and Configuration</b> .....	<b>71</b>
<b>Installing the System</b> .....	<b>72</b>
<b>Starting the System</b> .....	<b>76</b>
<b>Configuring the System</b> .....	<b>77</b>
Network Configuration .....	77
Using a Static IP .....	77
Using a Dynamic IP .....	77
Integrating Software Service .....	78
System Update .....	78
Management Tool R&S@Device Manager .....	78
<b>Shutting Down the System</b> .....	<b>79</b>
<b>Operation</b> .....	<b>81</b>
<b>Usable Software and Protocols</b> .....	<b>82</b>
<b>VENICE UI</b> .....	<b>83</b>
<b>Playing Content</b> .....	<b>84</b>
<b>Ingesting Content</b> .....	<b>85</b>
<b>Transforming Content</b> .....	<b>86</b>
<b>File Management</b> .....	<b>87</b>
<b>Configuring VENICE S Services</b> .....	<b>88</b>
Activating and Launching VDCP .....	88
Video Settings .....	90
<b>Configuring the Subtitles</b> .....	<b>92</b>
Subtitle Configuration in Device Manager .....	92
VDCP Subtitle Parameters .....	93
<b>Administration</b> .....	<b>95</b>
<b>User Management</b> .....	<b>96</b>
Changing the Passwords .....	96
Changing the User ID .....	97
Adding Samba Users .....	98
<b>Creating a Backup Image</b> .....	<b>99</b>
<b>Restoring the System</b> .....	<b>102</b>
<b>System Update</b> .....	<b>105</b>
<b>SNMP System Monitoring</b> .....	<b>106</b>
SNMP MIB files location .....	106
Understanding SNMP Naming .....	106
Basic System Monitoring via SNMP .....	107
Advanced System Monitoring via SNMP .....	109



<b>Integration into an IP Network</b> .....	<b>119</b>
Preconditions .....	119
General Network Settings .....	120
Installing the IP Software .....	123
Channel Configuration .....	123
Activating the SMPTE 2110 IP Interfaces .....	124
Configuring the PTP Sync Mode .....	125
Configuring the PTP Parameters .....	127
Configuring the NMOS Node Settings .....	128
NMOS Stream Configuration .....	128
<b>Working with the R&amp;S Installer (RSI)</b> .....	<b>145</b>
<b>Types of RSI Packages</b> .....	<b>146</b>
<b>Using an RSI</b> .....	<b>147</b>
<b>RSI Troubleshooting</b> .....	<b>149</b>
Logs .....	149
Error Codes .....	149
<b>Maintenance</b> .....	<b>153</b>
<b>Safety Instructions</b> .....	<b>154</b>
<b>Removing and Mounting the System Cover</b> .....	<b>156</b>
Removing the System Cover .....	156
Installing the System Cover .....	156
<b>Replacing a Power Supply Unit</b> .....	<b>158</b>
<b>Replacing a Hot Swappable Hard Drive</b> .....	<b>160</b>
<b>Replacing a Cooling Fan Assembly</b> .....	<b>162</b>
Replacing a Cooling Fan .....	163
<b>Replacing the Internal USB Memory Key</b> .....	<b>165</b>
<b>Transport</b> .....	<b>167</b>
<b>Safety Notes</b> .....	<b>168</b>
<b>Packing the System</b> .....	<b>169</b>
<b>Troubleshooting</b> .....	<b>171</b>
<b>Safety First - For you and your System</b> .....	<b>172</b>
<b>Troubleshooting External Connections</b> .....	<b>173</b>
<b>Troubleshooting the Video Subsystem</b> .....	<b>174</b>
<b>Troubleshooting a USB Device</b> .....	<b>175</b>
<b>Troubleshooting Power Supply Units</b> .....	<b>176</b>
Troubleshooting Power Source Problems .....	176
Power Supply Unit Problems .....	176
<b>Troubleshooting Cooling Problems</b> .....	<b>177</b>
Troubleshooting Cooling Fans .....	177
<b>Troubleshooting an Internal USB Key</b> .....	<b>178</b>
<b>Restarting a Single Channel</b> .....	<b>179</b>
<b>Disk Space Limit</b> .....	<b>180</b>
<b>Index</b> .....	<b>181</b>



# Safety and regulatory information

The product documentation helps you use the product safely and efficiently. Follow the instructions provided here and in the following chapters.

## Intended use

The R&S system may only be used according to its intended function as described in "Product Description" and within the specified environmental conditions as described in the data sheet. Any other use or extension of this function is considered inappropriate. Inappropriate use may lead to situations resulting in personal injury or property damage.

Observe the operating conditions and performance limits stated in the data sheet.

## Target audience

Each person who is responsible for installation, operation, maintenance or setting of the system must read and understand this manual.

To use this manual you should know how to handle computer equipment. Furthermore, to connect the R&S system to a network you should have experience as a network administrator and know how to set up the required network connections on the installation site both in hard- and software.

When performing maintenance tasks on the hardware of the R&S system, you must be qualified to work on, repair and test electrical equipment.

## Where do I find safety information?

Safety information is part of the product documentation. It warns you of potential dangers and gives instructions on how to prevent personal injury or damage caused by dangerous situations. Safety information is provided as follows:

- In chapter Safety instructions (page 8). The same information is provided in many languages as printed "Safety Instructions". The printed "Safety Instructions" are delivered with the product.
- Throughout the documentation, safety instructions are provided when you need to take care during setup or operation.

## Safety instructions

Products from the Rohde & Schwarz group of companies are manufactured according to the highest technical standards. To use the products safely, follow the instructions provided here and in the product documentation. Keep the product documentation nearby and offer it to other users.

Use the product only for its intended use and within its performance limits. Intended use and limits are described in the product documentation such as the data sheet, manuals and the printed "Safety Instructions". If you are unsure about the appropriate use, contact Rohde & Schwarz customer service.

Using the product requires specialists or specially trained personnel. These users also need sound knowledge of at least one of the languages in which the user interfaces and the product documentation are available.

If any part of the product is damaged or broken, stop using the product. Only service personnel authorized by Rohde & Schwarz are allowed to repair the product. Contact customer service at <http://www.customersupport.rohde-schwarz.com>.

### Lifting and carrying the product

The system can weigh up to 33.4 kg/73.6 lbs. Use appropriate lifting methods.

To move the product safely, you can use lifting or transporting equipment such as lift trucks and forklifts. Follow the instructions provided by the equipment manufacturer.

The product is heavy. Do not move or carry the product by yourself. A single person can only carry a maximum of 18 kg safely depending on age, gender and physical condition. Look up the maximum weight in the data sheet. Use the product handles to move or carry the product. Do not lift by the accessories mounted on the product. Accessories are not designed to carry the weight of the product.

### Choosing the operating site

Only use the product indoors. The product casing is not waterproof. Water that enters can electrically connect the casing with live parts, which can lead to electric shock, serious personal injury or death if you touch the casing. If Rohde & Schwarz provide accessories designed for your product, e.g. a carrying bag, you can use the product outdoors.

Unless otherwise specified, you can operate the product up to an altitude of 2000 m above sea level. The product is suitable for pollution degree 2 environments where nonconductive contamination can occur. For more information on environmental conditions such as ambient temperature and humidity, see the data sheet.

The system is to be operated only when mounted and mechanically secured into a 19-inch wide rack.

### Setting up the product

Always place the product on a stable, flat and level surface with the bottom of the product facing down. If the product is designed for different positions, secure the product so that it cannot fall over.

If the product has foldable feet, always fold the feet completely in or out to ensure stability. The feet can collapse if they are not folded out completely or if the product is moved without lifting it. The foldable feet are designed to carry the weight of the product, but not an extra load.

If stacking is possible, keep in mind that a stack of products can fall over and cause injury.

If you mount products in a rack, ensure that the rack has sufficient load capacity and stability. Observe the specifications of the rack manufacturer. Always install the products from the bottom shelf to the top shelf so that the rack stands securely. Secure the product so that it cannot fall off the rack.

Unplug the system before you move it or if you think it has become damaged in any way.

### Connecting to power

The product is an overvoltage category II product. Connect the product to a fixed installation used to supply energy-consuming equipment such as household appliances and similar loads. Keep in mind that electrically powered products have risks, such as electric shock, fire, personal injury or even death.

Take the following measures for your safety:

- The enclosure must only be operated from a power supply input voltage range of 100-240 VAC, frequency is 50 to 60 Hz.
- Before switching on the product, ensure that the voltage and frequency indicated on the product match the available power source. If the power adapter does not adjust automatically, set the correct value and check the rating of the fuse.
- Only use the power cable delivered with the product. It complies with country-specific safety requirements. Only insert the plug into an outlet with protective conductor terminal.
- Only use intact cables and route them carefully so that they cannot be damaged. Check the power cables regularly to ensure that they are undamaged. Also ensure that nobody can trip over loose cables.
- If the product needs an external power supply, use the power supply that is delivered with the product or that is recommended in the product documentation or a power supply that conforms to the country-specific regulations.
- Only connect the product to a power source with a fuse protection of maximum 20A.

## Safety instructions

- Ensure that you can disconnect the product from the power source at any time. Pull the power plug to disconnect the product. The power plug must be easily accessible. If the product is integrated into a system that does not meet these requirements, provide an easily accessible circuit breaker at the system level.

**Handling batteries safely**

The product contains exchangeable or built-in lithium polymer or lithium ion cells or batteries. The use of the word battery in the following always means all types. Only the battery contents are potentially hazardous. As long as a battery is undamaged and the seals remain intact, there is no danger.

Impact, shock or heat can cause damage such as dents, punctures and other deformations. A damaged battery poses a risk of personal injury. Handle a damaged or leaking battery with extreme care. Immediately ventilate the area since the battery releases harmful gases. If you come into contact with the battery fluid, immediately remove all contaminated clothing. Irritation can occur if the battery fluid comes in contact with your skin or eyes. Immediately and thoroughly rinse your skin or eyes with water and seek medical aid.

For safe handling, follow these rules:

- Do not short-circuit the battery.
- Do not mechanically damage the battery. Do not open or disassemble the battery.
- Do not expose the battery to high temperatures such as open flames, hot surfaces and sunlight.
- Only use the battery with the designated product.
- Only use the appropriate charger to charge the batteries. If the batteries are improperly charged, there is a risk of explosion. For charging and discharging temperature ranges, see the product documentation.
- Replace exchangeable batteries only with the same battery type.
- Store the battery in the product or use the product packaging.
- Dispose of exchangeable batteries separately from normal household waste as specified by the local waste disposal agency.

If you disregard these rules, you risk serious personal injury or even death due to explosion, fire or hazardous chemical substances. The product documentation provides further details.

If exchangeable batteries or products with built-in batteries are defective, contact the customer service. Rohde & Schwarz classifies the severity of the defect. When returning batteries or Rohde & Schwarz products containing batteries, use a carrier qualified to transport dangerous goods and notify the carrier of this classification. Follow the carrier's transport stipulations in line with IATA-DGR, IMDG-Code, ADR or RID.

**Cleaning the product**

Use a dry, lint-free cloth to clean the product. When cleaning, keep in mind that the casing is not waterproof. Do not use liquid cleaning agents.





### Connecting to a network

Before connecting the product to a local area network (LAN), consider the following:

- Always install the latest firmware for the components of your system to reduce security risks.
- For Internet or remote access, use secured connections if applicable, such as HTTPS, SFTP, FTPS instead of HTTP, FTP.
- Ensure that the network settings comply with the security policies of your company. Contact your local system administrator or IT department before connecting your product to your company network.
- When connected to a network, the product may potentially be accessed from the Internet, which may be a security risk. For example, attackers might misuse a network to remotely access and damage the product

### Meaning of safety labels

Safety labels on the product warn against potential hazards.

	<p>Potential hazard</p> <p>Read the product documentation to avoid personal injury or product damage.</p>
	<p>Heavy product</p> <p>Be careful when lifting, moving or carrying the product. Carrying the product requires at least two people or transport equipment.</p>
	<p>Electrical hazard</p> <p>Indicates live parts. Risk of electric shock, fire, personal injury or even death.</p>
	<p>Hot surface</p> <p>Do not touch. Risk of skin burns. Risk of fire.</p>
	<p>Protective conductor terminal</p> <p>Connect this terminal to a grounded external conductor or to protective ground. This protects you against electric shock should an electric problem occur.</p>

Labels on the Product

## Labels on the Product

Labels on the casing inform about:

- Personal safety, see "Safety instructions" on page 8
- Product and environment safety, see table below.
- Identification of the product

### Labels regarding product and environment safety

	Labeling in line with EN 50419 for disposal of electrical and electronic equipment after the product has come to the end of its service life.
-----------------------------------------------------------------------------------	-----------------------------------------------------------------------------------------------------------------------------------------------



## Warning Messages in the Documentation

A warning message points out a risk or danger that you need to be aware of. The signal word indicates the severity of the safety hazard and how likely it will occur if you do not follow the safety precautions.

### **DANGER**

Imminently hazardous situation. Will result in death or serious injury if not avoided.

### **WARNING**

Potentially hazardous situation. Could result in death or serious injury if not avoided.

### **CAUTION**

Potentially hazardous situation. Could result in minor or moderate injury if not avoided.

### **NOTICE**

Potential risks of damage. Could result in damage to the supported product or to other property.

Where to find key documents on Rohde & Schwarz

## Where to find key documents on Rohde & Schwarz

Certificates issued to Rohde & Schwarz that are relevant for your country are provided at <https://www.rohde-schwarz.com/key-documents>", e.g. concerning:

- Quality management
- Environmental management
- Information security management
- Accreditations

## General Notes

Please observe the following general important notes:

- Computer hardware contains components that are sensitive to electrostatic discharge. If you touch them without precautionary measures, they can be destroyed. Use a wrist strap connected to ground when accessing electronic parts and take care of grounding the system. Avoid touching the internal components of R&S VENICE S G3 whenever possible.
- Performance Loss:  
R&S VENICE S G3 has been delivered to you fully preconfigured and optimized for a real-time in- and output of video streams. Changing any of the settings (e.g. the hardware, software and/or BIOS settings) may lead to a loss of performance or may even render the system unusable. Re-configuring R&S VENICE S G3 anew in most cases is a lengthy procedure. Modifications of settings i.e. BIOS settings shall be done with Rohde & Schwarz.
- Data loss/corrupt data  
In the event of a power failure the device will be abruptly switched off. This can result in corrupt data, loss of data, and equipment damage. Connect the system to an uninterruptible power supply (UPS) redundantly on two phases.
- Third-party Software:  
VENICE is built for the most demanding realtime operations. Third-party software might have unpredictable influences to the overall performance and stability of the system. Do not install any third-party software that has not been tested and approved by Rohde & Schwarz on your system.
- Real-time performance:  
Use only the optional internal storage or external storage solutions which are tested and released by Rohde & Schwarz to store video and audio data. Other storage locations and solutions will be too slow for real-time operations.
- Storage capacity exceeded:  
In case of a full storage performance losses may occur. Leave about 10 to 15 % of the overall main storage capacity empty of data for performance reasons.
- It is recommended to set up an e-mail notification, to ensure you get informed when a hardware malfunction occurs.

---

### **NOTICE**

#### **Authentication Security**

To ensure the safety of systems connected in a network and/or to the Internet, we highly recommend to change the default password on both the VENICE S server as well as the on the web UI of R&S@Device Manager as soon as the initial setup is completed.

**For more information, see section "Changing the Passwords" (page 96)**

---

Korea Certification Class A

## Korea Certification Class A



이 기기는 업무용 (A 급) 전자파 적합기기로서 판매자 또는 사용자는 이 점을 주의하시기 바라며, 가정외의 지역에서 사용하는 것을 목적으로 합니다.

# Documentation overview

This section provides an overview of the user documentation. Unless specified otherwise, you find the documents at the official product page or in the customer portal GLORIS.

This chapter includes the following section:

- "About this Documentation" (page 18)

## About this Documentation

This documentation informs you about the installation of the R&S VENICE S G3 hardware, a video server system by Rohde & Schwarz, its operation as well as all connection possibilities. Furthermore, it describes maintenance tasks that you may carry out on your own.

### Required Reading

Each person who is responsible for installation, operation, maintenance or setting of the system has to read and understand this manual.

### Additional Documentation

Following documents have to be also taken into consideration when working with R&S VENICE S G3:

- Data Sheet
- Safety, Environment and Regulatory Information
- Getting Started Guide
- Software Integration Guide
- VENICE UI Software Manual
- Supported File Formats for all software versions

The complete documentation can be accessed on <https://gloris.rohde-schwarz.com> after registering/logging in or directly on the R&S product page. There you may find updated manuals and further information as well.

# Product Description

This chapter is divided into the following sections:

- "Function" (page 20)
- "Models" (page 21)
- "Features" (page 22)
- "Type Plate and Serial Number" (page 33)
- "Scope of Delivery" (page 35)
- "The Front of the System" (page 36)
- "The Rear of the System" (page 40)
- "Inside the System" (page 51)
- "Pin Assignment" (page 55)
- "Network Ports" (page 60)

## Function

R&S VENICE S G3 is a media server especially designed for studio production as well as channel playout. It offers ingest, playout and transforming functions in one single box. The open software structure allows to combine video and IT workflows in broadcast environments.

In playout mode R&S VENICE S G3 assumes the role of a player. For a remote controlled playout set R&S VENICE S G3 in VDCP or MOS mode via R&S VENICE web service or the R&S<sup>®</sup>Device Manager.

In ingest mode R&S VENICE S G3 assumes the role of a recorder. For a remote controlled ingest set R&S VENICE S G3 in FIMS or VDCP mode via R&S VENICE web service or the R&S<sup>®</sup>Device Manager.

In transform mode R&S VENICE S G3 transforms video and audio material to different file formats. If possible, the file conversion (transcoding) will be performed in hardware at a faster render speed. For a remote controlled transform set R&S VENICE S G3 in FIMS mode via R&S VENICE web service or the R&S<sup>®</sup>Device Manager.

For more information about the integration of R&S VENICE S G3 by VDCP, MOS, FIMS and the R&S VENICE web service please see the Software Integration Guide, available at:

**<https://gloris.rohde-schwarz.com>**.

There's no graphical Desktop on the R&S VENICE S, so you got to communicate to it via either:

- text console on locally connected monitor and keyboard (front or rear connectors)
- remote SSH console („Putty“ or „MobaX“ on Windows PC or laptop)
- remote R&S<sup>®</sup>Device Manager (via browser on Windows PC or laptop)



## Models

The following models are available:

- R&S VENICE S800 (no internal media storage)
- R&S VENICE S824 (24 TB internal media storage)

## Features

- **On-air reliability:** The entire system has no single point of failure due to the redundancy of every system-relevant component.
- **SDI and IP functionality:** Equipped with a new video I/O board, R&S VENICE S G3 offers SDI and IP functionality.
- **Flexible system design:** R&S VENICE S G3 can be scaled to meet your requirements, no matter how many channels and how much storage capacity or bandwidth you need.
- **UHD and HDR ready:** R&S VENICE S G3 supports up to two UHD p60 channel (bidirectional) and eight HD p60 channels (bidirectional) and handles HDR material with ease.
- **Standard server platform:** R&S VENICE S G3 uses a standard IT server whose reliability and performance has proven itself a thousand times over in data centers worldwide.
- **Comprehensive software-based codec support:** R&S VENICE S G3 minimizes the need for transcoding by supporting a variety of software-based codecs that can be expanded via future software updates.
- **Service-oriented architecture:** FIMS and web services communications allow the greatest possible interoperability, flexibility and integrability in the broadcast value chain. R&S VENICE S G3 is easy to integrate into existing infrastructures and can be dynamically adapted to meet any requirement.
- **Storage options:** R&S VENICE S G3 can be equipped with up to 24 terabyte internal RAID storage and connected to external storage solutions.

### Channel Configuration

R&S VENICE can be set to HD/SD or UHD-1 operation via the R&S<sup>®</sup> Device Manager.

#### HD/SD:

- eight bidirectional HD/SD channels
- optional transform functionality per channel
- automatic aspect ratio conversion (ARC) with active format descriptor (AFD) support

#### UHD:





- two bidirectional UHD-1 channel
- optional transform functionality
- one HD downconversion output per channel (locked to UHD-1 channel)

### Workflow-based Metadata





R&S VENICE S G3 enables you to use the process of closed captioning (CC) and subtitling (STL), so that it can be decoded and displayed on a television, video screen, or other visual displays.

### VBI-ANC Handling

R&S VENICE S G3 supports the read out of VBI (vertical blanking interval) information. VBI information will be converted to ANC on any output raster.

INPUT		PLAYOUT	OUTPUT	
ANC & VBI Closed Caption			ANC Closed Caption	
SD-SDI V-Lines: 525	VBI CEA-608 data ANC CEA-608 data ANC & VBI CEA-608 data <sup>1</sup>		SD-SDI V-Lines: 625	ANC CEA-608 data (SMPTE 334-1)
			HD-SDI	ANC Closed captioning (CEA-708) (CDP) (SMPTE 334-1)
HD-SDI	ANC Closed captioning (CEA-708) (CDP) ANC CEA-608 data		SD-SDI V-Lines: 625	ANC CEA-608 data (SMPTE 334-1)
			HD-SDI	ANC Closed captioning (CEA-708) (CDP) (SMPTE 334-1)



1.particular case

INPUT		PLAYOUT	OUTPUT	
ANC & VBI Closed Caption			ANC Closed Caption	
SD-SDI V-Lines: 625	VBI OP-42 ANC OP-47 ANC & VBI OP-47/42 <sup>1</sup>		SD-SDI V-Lines: 625	ANC OP-47 (SMPTE 2031)
			HD-SDI	ANC OP-47 (SMPTE 2031)
HD-SDI	ANC OP-47		SD-SDI V-Lines: 625	ANC OP-47 (SMPTE 2031)
			HD-SDI	ANC OP-47 (SMPTE 2031)

1.particular case

The following VBI information will be converted to ANC:

## Features

VBI		ANC (SMPTE 291)
WSS (Wide Screen Signaling, ETSI EN 300 294)		AFD (Active Format Description, SMPTE 2016)
VBI OP-42 (Teletext/Subtitles)		ANC OP-47 (SMPTE 2031)
Line 21 (VBI CEA-608 data) (CC)		ANC CEA -608/708 (SMPTE 334-1)

ANC packages can be saved in QuickTime (CC only) and MXF OP1a files according to SMPTE 436.

### Closed Caption

R&S VENICE S G3 allows pass through of embedded closed captions, insertion from closed caption files and SD/HD up and down conversion. Thereby SD closed captions conforms to the CEA-608. HD closed captions uses CEA-608 captions encapsulated within CEA-708 packets.

R&S VENICE S G3 supports embedded closed caption information stored in QuickTime (MOV). It records embedded CEA-708 information from the incoming SDI signal in digital SD and HD.

When writing QuickTime files (ingest or transform) the closed caption data are preserved in the following order whereas the first type found is written into the files:

- 1 CEA-708 ANC (digital)
- 2 CEA-608 ANC (digital)

By default it is a QuickTime CEA-708 track ('c708').

A closed caption track will only be added to QuickTime files if valid closed caption data is detected on the first frame of the provided input or if writing of such a track has been enforced in the R&S VENICE software (available with software version 3.5), in the R&S®Device Manager (available with software version 4) or via R&S VENICE web service command **configureCodecRequest**.

Furthermore, closed captions are stored in MXF OP-1a files as defined in the SMPTE 436M standard. The closed captions are preserved with a head and tail trim. Then they can be played out to SDI again.

Multiple languages can be inserted into four data channels on line 21 from separate closed caption files. The first and the second closed caption track will be placed into field 1 of the video frame. If more tracks will be necessary closed caption information also can be written in a separate \*.scc file. For this additional scc 3 files have to be enabled in the video settings of the R&S®Device Manager. Field 2 of a video frame then transfer closed caption tracks three and four.

For playout purposes external \*.scc files can be inserted to the SDI signal.



If transcoding one file format into another file format during ingest as well as transcoding the closed caption information could be lost with the following format: MXF (OP Atom, Sony XDCam IMX, AS02, AS11, IMF).

Closed Captions cannot be lost with the following formats: MOV, MXF (OP1a Generic, RDD09, Sony XDCam DV, XAVC) and MPEG-2.

### Subtitles

R&S VENICE S G3 allows pass-through of embedded subtitles, insertion from subtitle files and SD/HD up and down conversion.

R&S VENICE S G3 supports embedded subtitling information in MXF OP1a files or additional in separate \*.stl files. Subtitles can be read and written according to EBU Tech 3264-E.

For playout purposes, external \*.stl files for multiple languages can be inserted into the SDI signal.

The subtitles configuration for R&S VENICE is done in the R&S®Device Manager tool. If the respective "Record Subtitle Type" is enabled in the Subtitle Settings, the system automatically uses subtitles, if available. The "Subtitle File Path" setting in the "VDCP Settings" section is used to specify the directory where the system looks for subtitle files.



For working instructions on how to perform these settings, see section "Configuring the Subtitles" on page 92.

Currently R&S VENICE S G3 supports Latin and Greek character sets.

### Aspect Ratio

There are many technical issues while dealing with SD and HD content. SD content can be available in 16:9 or 4:3. HD content is always 16:9. A broadcaster must be able to playout all three types of material and switch seamlessly between them all. The aspect ratio can be changed at various points in the broadcast chain.

To get an optimal picture it is important that the format bring accurate information with it. Outside the US, WSS (Wide Screen Signaling) was sometimes used with SD signals to define the aspect ratio. The information was stored on VBI line 20 for NTSC and line 23 for PAL. Meanwhile AFD has replaced WSS for both, SD and HD material.

AFD (Active Format Description) describes the video picture in terms of the aspect ratio and other characteristics of the active image within the coded frame.

## Features

With one of the following values in the "AFD Data Mode" in the R&S®Device Manager or via the R&S VENICE web service it can be determined, if the existing AFD data file should be used or if this data should be overwritten:



If transcoding one file format into another file format during ingest as well as transcoding the AFD information could be lost with the following format: MXF (OP Atom, Sony XDCam IMX, AS02, AS11, IMF).

AFD data couldn't be lost with following formats: MXF (OP1a Generic, RDD09, Sony XDCam DV, XAVC) and MPEG-2.

<b>Strip</b>	All AFD data is removed.
<b>PassThrough</b>	The existing AFD data is passed through.
<b>Generate</b>	The existing AFD data is passed through. If no AFD data is present, AFD data is generated based on the current settings.
<b>Replace</b>	The AFD data is always generated based on the current settings. Existing AFD data is replaced.

The „AFD Reset Mode“ can used to determine whether the AFD overwrite should be valid only for this clip or until further notice.

### Supported Conversion Using AFD

R&S VENICE S G3 can be configured for SD, HD and UHD payout. So the server supports many different clip-related aspect ratio conversions (ARC) as shown in the following:

AFD In	Input (4:3)	AFD Out	Output (16:9)
0001	Reserved	-	Invalid
0010	Letterbox 16:9 image, at the top of the coded frame	1000	Full frame 16:9 image, the same as the coded frame
0011	Letterbox 14:9 image, at the top of the coded frame	1011	Pillarbox 14:9 image, horizontally centered in the coded frame
0100	Letterbox image with an aspect ratio greater than 16:9, vertically centered in the coded frame	0100	Letterbox image with an aspect ratio greater than 16:9, vertically centered in the coded frame
0101	Reserved	-	Invalid
0110	Reserved	-	Invalid
0111	Reserved	-	Invalid
1000	Full frame 4:3 image, the same as the coded frame	1001	Pillarbox 4:3 image, horizontally centered in the coded frame

AFD In	Input (4:3)	AFD Out	Output (16:9)
1001	Full frame 4:3 image, the same as the coded frame	1001	Pillarbox 4:3 image, horizontally centered in the coded frame
1010	Letterbox 16:9 image, vertically centered in the coded frame with all image areas protected	1010	Full frame 16:9 image, with all image areas protected
1011	Letterbox 14:9 image, vertically centered in the coded frame	1011	Pillarbox 14:9 image, horizontally centered in the coded frame
1100	Reserved	-	Invalid
1101	Full frame 4:3 image, with alternative 14:9 center	1101	Pillarbox 4:3 image
1110	Letterbox 16:9 image, with alternative 14:9 center	1110	Full frame 16:9 image
1111	Letterbox 16:9 image, with alternative 4:3 center	1111	Full frame 16:9 image

AFD In	Input (16:9)	AFD Out	Output (4:3)
0001	Reserved	-	Invalid
0010	Full frame 16:9 image, the same as the coded frame	1010	Letterbox 16:9 image, vertically centered in the coded frame with all image areas protected
0011	Pillarbox 14:9 image, horizontally centered in the coded frame	1011	Letterbox 14:9 image, vertically centered in the coded frame
0100	Letterbox image with an aspect ratio greater than 16:9, vertically centered in the coded frame	0100	Letterbox image with an aspect ratio greater than 16:9, vertically centered in the coded frame
0101	Reserved	-	Invalid
0110	Reserved	-	Invalid
0111	Reserved	-	Invalid
1000	Full frame 16:9 image, the same as the coded frame	1010	Letterbox 16:9 image, vertically centered in the coded frame with all image areas protected
1001	Pillarbox 4:3 image, horizontally centered in the coded frame	1000	Full frame 4:3 image, the same as the coded frame
1010	Full frame 16:9 image, with all image areas protected	1010	Letterbox 16:9 image, vertically centered in the coded frame with all image areas protected

## Features

AFD In	Input (16:9)	AFD Out	Output (4:3)
1011	Pillarbox 14:9 image, horizontally centered in the coded frame	1011	Letterbox 14:9 image, vertically centered in the coded frame
1100	Reserved	-	Invalid
1101	Pillarbox 4:3 image, with alternative 14:9 center	1101	Full frame 4:3 image, with alternative 14:9 center
1110	Full frame 16:9 image, with alternative 14:9 center	1110	Letterbox 16:9 image, with alternative 14:9 center
1111	Full frame 16:9 image, with alternative 4:3 center	1111	Letterbox 16:9 image, with alternative 4:3 center



In the following figure represent the most common conversions.

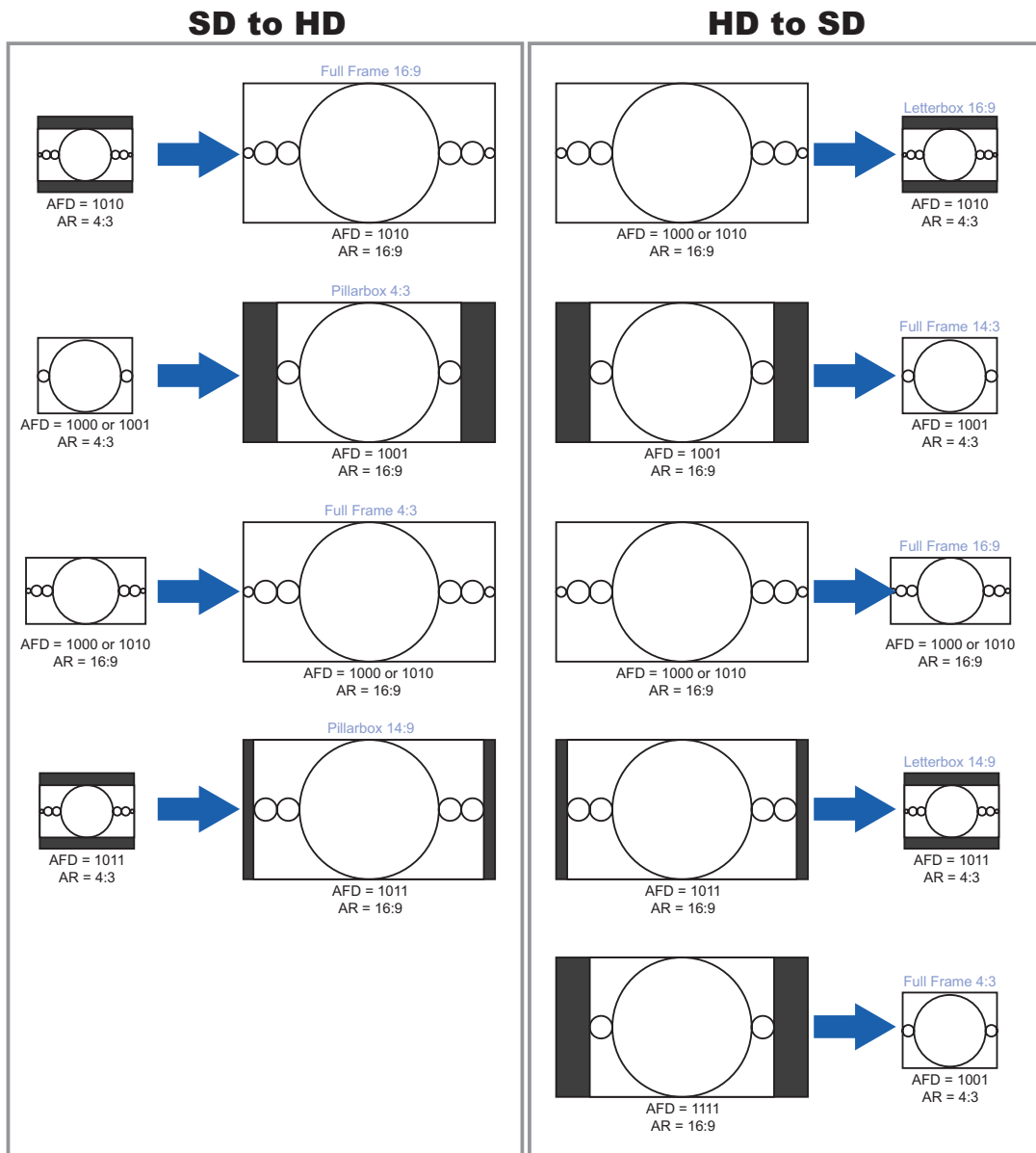

Incorrectly set AFD's are ignored.

At any time AFD values might be overwritten with the R&S VENICE web service command **ActiveFormatBase**. This setting is also possible in the R&S® Device Manager. Furthermore you can scale and resize the video material if output format and the format of the video material are different. Therefore the following parameters are available:

## Features

<b>Off</b>	The material will maintain its original size.
<b>Box</b>	The original material will be scaled to its maximum allowable width or height so that no information gets lost. If the aspect ratio is different, you will receive black bars in the output.
<b>Crop</b>	The images will be scaled to their maximum allowable width or height so that you receive a full image at the output. If the aspect ratio is different, parts of the images will be cropped.
<b>Fit</b>	The aspect ratio will not be preserved. The resulting images will be stretched or compressed if the aspect ratio is different and you will always receive a full image in the output.
<b>Active Format Based</b>	The scaling will be performed based on the "Supported Conversion Using AFD" on page 26.

## Audio Routing

The R&S<sup>®</sup>Device Manager allows an easy audio routing of every video channel.

### DolbyE

R&S VENICE S supports the pass through of DolbyE audio. Thereby DolbyE tracks will be handled as PCM audio. For example: if an MXF file has 8 channels of PCM audio, it is possible that the first two channels (1 and 2) transfer DolbyE while the other channels (3 -6) transfer normal PCM audio. It is also possible the other way around, so that the first six channels transfer PCM audio and the last two channels DolbyE.

## Image Processing



R&S VENICE supports upscaling during playout and transform operations.

		OUTPUT											
		480i29.97	576i25	720p50	720p59.94	1080p25	1080p/9.97	1080i25	1080p50	1080i29.97	1080p59.94	2160p50	2160p59.94
INPUT	480i29.97	x							x				
	576i25		x					x					
	720p50			x		x			x			x	
	720p59.94				x		x				x		x
	1080p25			x		x			x			x	
	1080p29.97				x		x			x	x		x
	1080i25		x						x				
	1080p50			x		x				x			x
	1080i29.97	x								x			
	1080p59.94				x		x				x		x
	2160p50			x		x				x		x	
	2160p59.94				x		x				x		x

## Timecode

R&S VENICE S G3 supports a wide range of timecode types:

- Internal
- Generic (Timecode of media file)
- LTC (Longitudinal Timecode)
- VITC (Vertical Interval Timecode)
- VTRTC (RS-422 Timecode)
- DVITC (Digital Vertical Interval Timecode)
- DLTC (Digital Longitudinal Timecode)
- Time of day

On video tapes the VITC is basically stored for each frame in one video line of the vertical blanking interval. While the LTC is recorded along the tape, mostly for this, an audio track is used. In opposite to VITC, the LTC can be read out during a fast forward and written later. Certainly during a still image (paused) or during a slow forward the LTC can not be read out. With VITC it's possible.

## Features

DLTC and DVITC is inserted in the vertical blanking interval of the SDI-Signal. It won't be published in the video image. DVITC replaces the previously used VITC of analog systems. DVITC will be recorded most preferably in line 9 and 10 of the SDI signal at the output of MAZ devices.

VTRTC (RS-422) is a via RS-422 transferred timecode of a controlled video source.

Time of day is the actual time of the device.

### Play After Write

The automated play after write functionality allows a true visual quality check. It reads the open file being currently recorded directly from the disk. The operator can see the file and can judge its quality directly after the video has passed the encoding process and has been written to the storage.



Please note that for the play after write feature an additional channel for playout is needed. Furthermore, the ingest and playout channels need to be on the same R&S VENICE server.

## Type Plate and Serial Number

The serial number of the system is located on the type plate.

### Type Plate

The type plate itself is located on the slide-out panel (information tag) which can be accessed on the front of the system (bottom right).

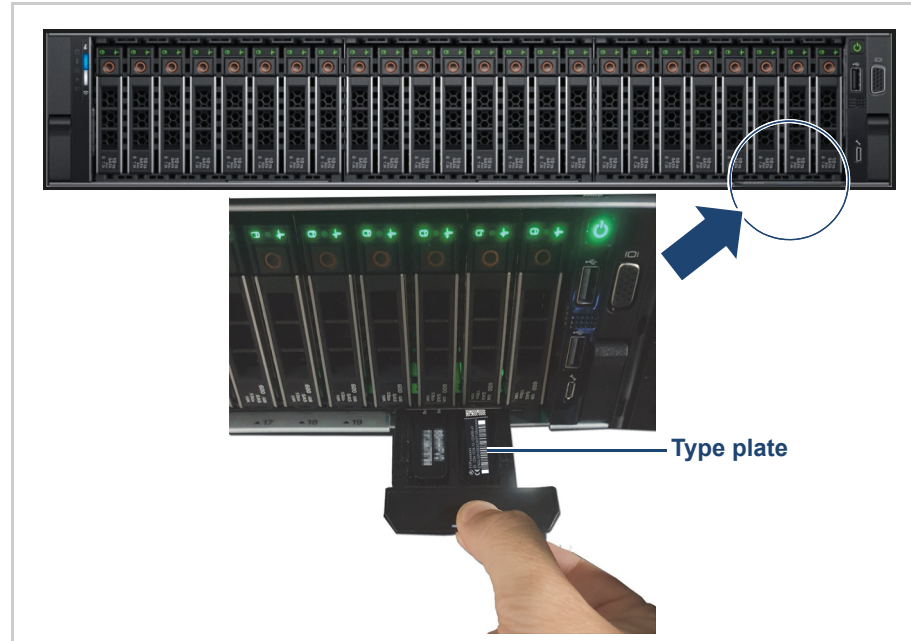

Location of the type plate on the slide-out panel

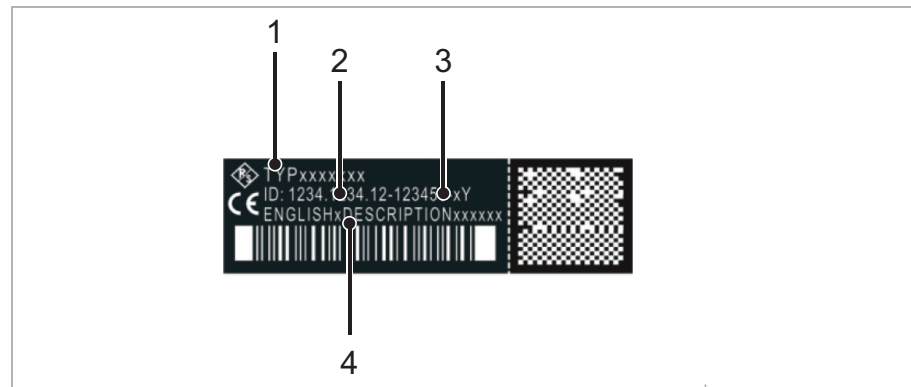

Type plate

1	Type
2	Article number
3	Serial number, see also "Serial Number" (page 34)
4	Product description

## Type Plate and Serial Number

### Serial Number

The serial number is part of the system ID. It is the 6-digit number that comes after the article number:

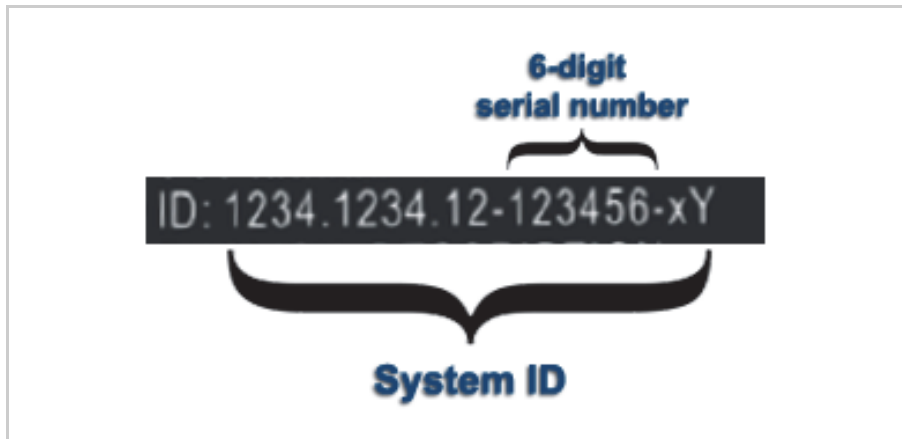

*Serial number as part of the system ID*



This 6-digit serial number is used as password when logging in to:

- R&S® Device Manager web frontend (username: "administrator")
- R&S VENICE S server (username: "root")
- iDRAC login (username: "root"). For systems built after April 2022 prepend "rs" to the beginning of the serial number (e.g "rs123456").

## Scope of Delivery

The following components are included:

- R&S VENICE S G3 chassis
- Rack mount kit
- Cable management kit
- Power cable (rack)
- 2x SR SFP+ 10GbE optical transceiver
- 8x SDI 3G SFP bundle: SDI 3G combined input and output SFPs for 8 bidirectional HD/SDI channels (includes 4x 3G dual receiver and 4x 3G dual transmitter)
- Product documentation

**Optional:**

- 2x R&S VENICE accessory kit: 8x HD-BNC to BNC adapter cables, 4x RJ45 to DB9-adapter cables (RS422), 1x HD-D-SUB 26 male to 8 x XLR female/male breakout cables.

The Front of the System

## The Front of the System

### Front Plate

The front of the system is equipped with a front cover for mechanical protection and sufficient air circulation.

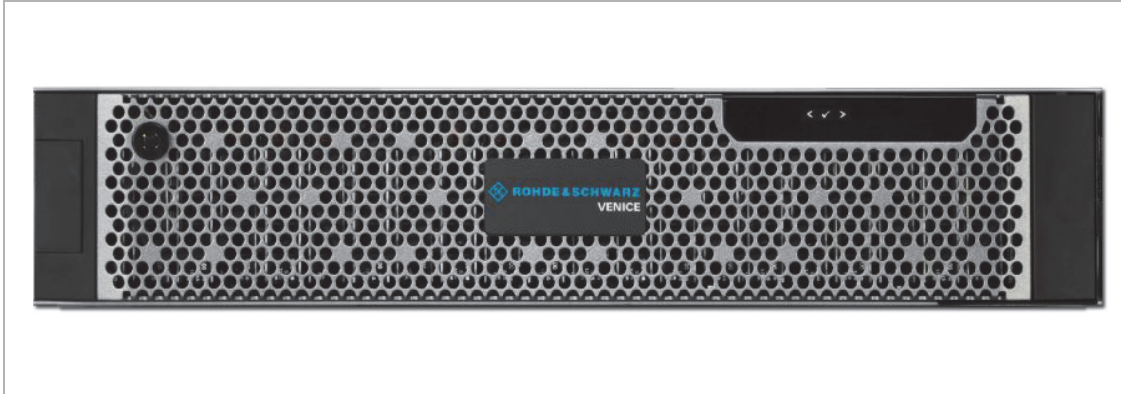

Front plate

### Chassis Front

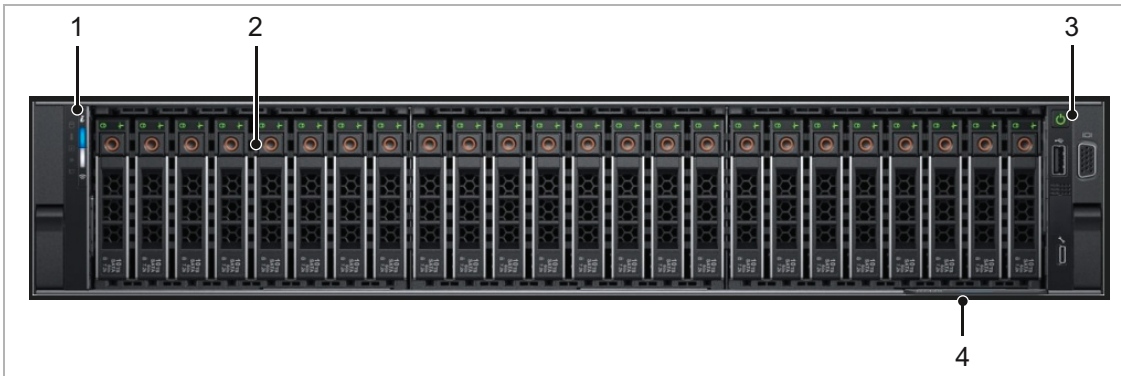

Chassis front

1	Left control panel	Contains system health and system ID, status LED and optional iDRAC Quick Sync 2 (wireless). For more information see chapter "Left Control Panel" on page 37
2	Hard drives	Up to 30 2.5-inch hot-swappable hard drives.
3	Right control panel	Contains the power button, VGA port, iDRAC Direct micro USB port, and a USB 2.0 port. For more information see chapter "Right Control Panel" on page 37
4	Information tag	Contains system information such as service tag, NIC, MAC address for your reference. The information tag is a slide-out label panel, see also "Type Plate and Serial Number" on page 33.



**Left Control Panel**

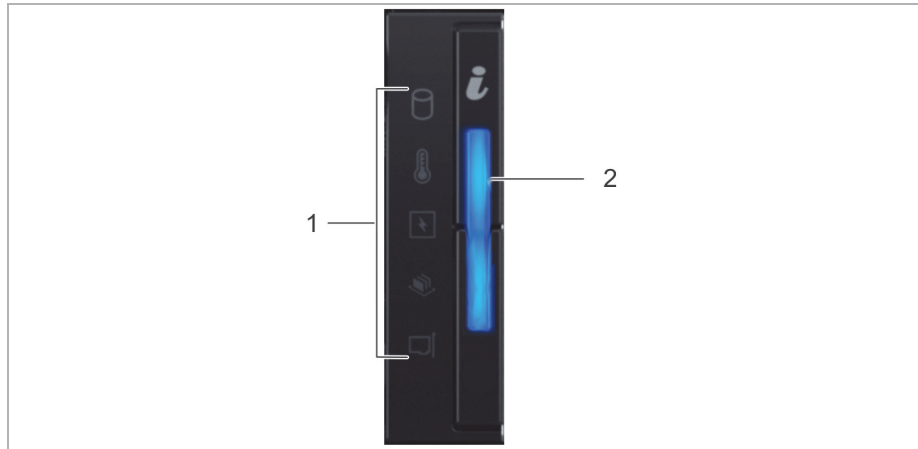



*Control panel left*

<b>1</b>	Status LED indicators	N/A	Indicate the status of the system.
<b>2</b>	System health and system ID indicator		Indicates the system health.

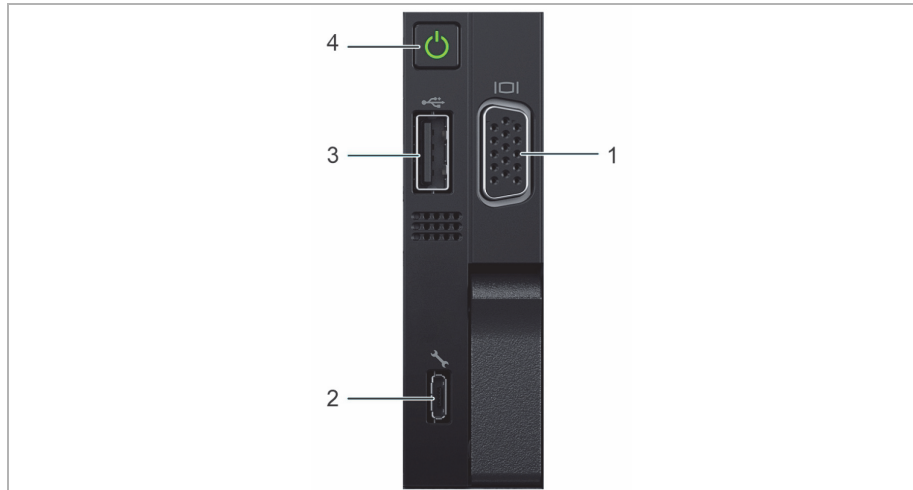

**Right Control Panel**



*Control panel right*

<b>1</b>	Video connector		Enables you to connect a VGA display to the system.
<b>2</b>	iDRAC Direct port		Enables you to connect micro USB devices to the system or to access the iDRAC service features.

The Front of the System

3	USB port		Enables you to connect USB devices to the system. The ports are USB 2.0 compliant.
4	Power button		Indicates if the system is powered on or off. Press the power button to manually power on or off the system.

Hard Drives

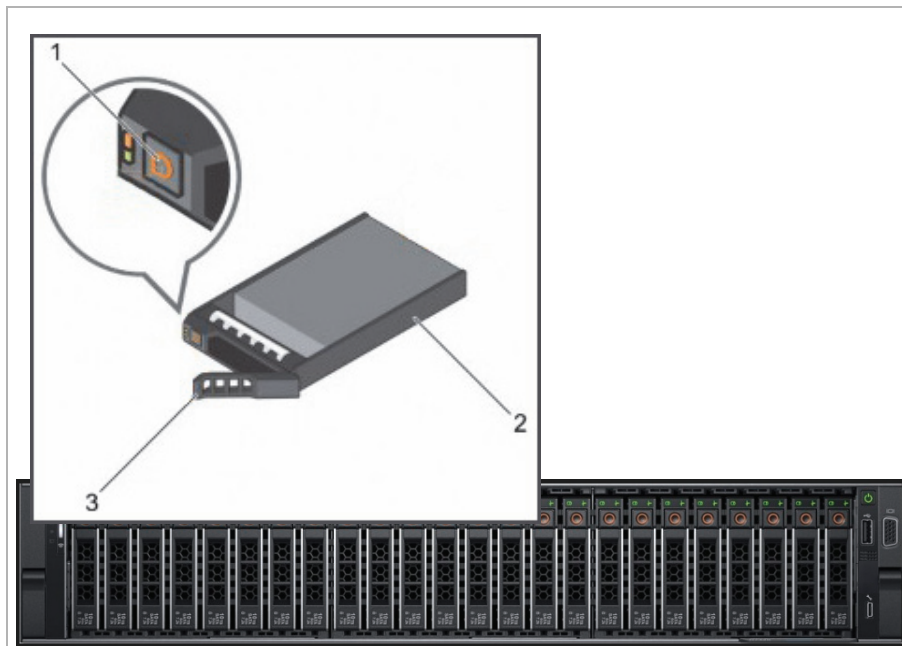

Hard drives

1	Release button
2	Hard drive carrier
3	Hard drive carrier handle

For more information about removing and installing a hard drive see chapter “Replacing a Hot Swappable Hard Drive” on page 160.

### Hard Drive Indicators

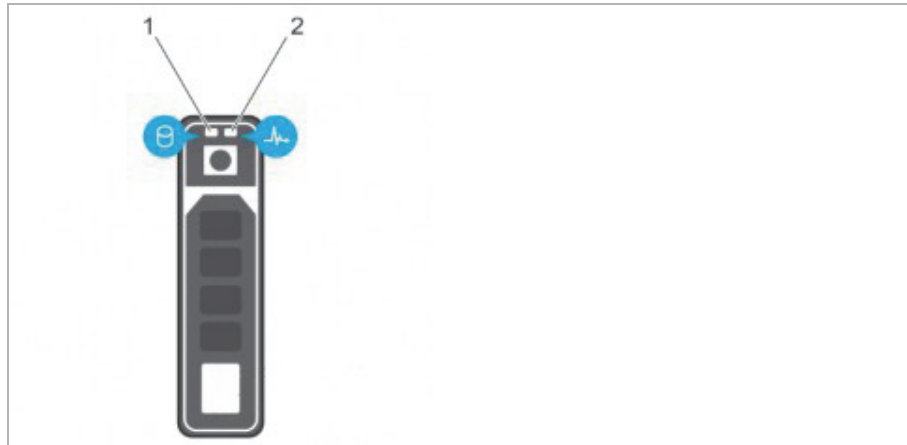

Hard drive indicators

1	Hard drive activity indicator
2	Hard drive status indicator



If the hard drive is in the Advanced Host Controller Interface (AHCI) mode, the status indicator (on the right side) does not function and remains off.

### Hard Drive Indicator Codes

Flashes green twice per second	Identifying drive or preparing for removal.
Off	Drive ready for insertion or removal. <b>NOTE: The drive status indicator remains off until all hard drives are initialized after the system is turned on. Drives are not ready for insertion or removal during this time.</b>
Flashes green, amber, and turns off	Predicted drive failure
Flashes amber four times per second	Drive failed
Flashes green slowly	Drive rebuilding
Steady green	Drive online
Flashes green for three seconds, amber for three seconds, and turns off after six seconds	Rebuild stopped





The Rear of the System

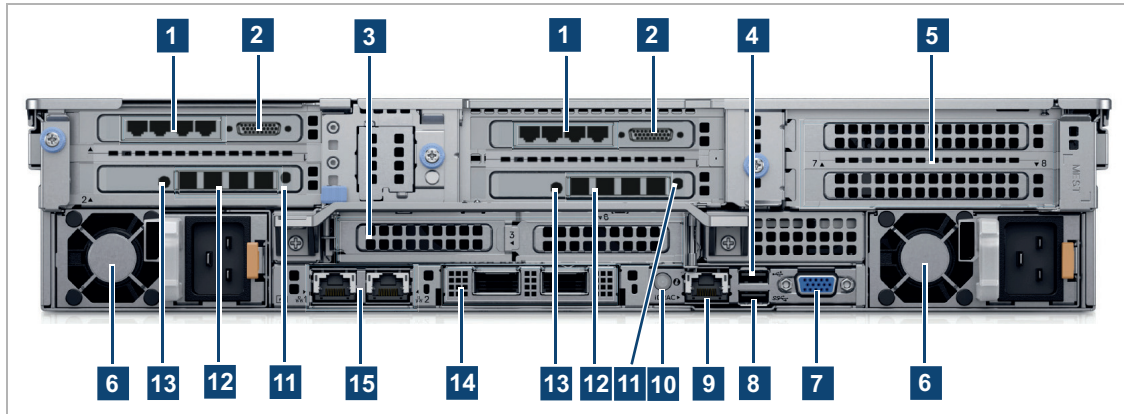

# The Rear of the System

## Back Panel



Back panel

1	RJ45 connector, serial RS-422 interface (4)	N/A	Out- or input of primary/secondary control signals For more information see "Out- or Input of Primary/Secondary Control Signals" on page 43 and for the pin assignment chapter "RJ45 Connector" on page 56.
2	HD Sub-D connector	N/A	LTC In/Out For more information see "LTC In/Out" on page 41 and for the pin assignment "HD Sub-D Connector (LTC In/Out)" on page 55.
3	2 x PCIe expansion card (slot 3 and slot 6)	N/A	Provides slots for two PCI Express expansion cards.
4	USB 2.0 port)		Enables you to connect USB devices to the system. This port is USB 2.0-compliant.
5	2 x PCIe expansion card (slot 7 and slot 8)	N/A	Provides slots for two PCI Express expansion cards.
6	Power supply unit (PSU) (2)	N/A	AC 2400 W For more information see chapter "Power Supply Unit" on page 42.
7	Video connector		Enables you to connect a VGA display to the system. For the pin assignment see chapter "Video Connector" on page 57.
8	USB port (2)		Enables you to connect USB devices to the system. This port is USB 3.0-compliant.
9	iDRAC Enterprise port		Dedicated management port.
10	System identification button		The identification buttons on the front and back panels can be used to locate a particular system within a rack. When one of these buttons is pressed, the LCD panel on the front and the system status indicator on the back flashes until one of the buttons is pressed again. Press to toggle the system identification (ID) on or off.

11	SDI Sync Ref in	N/A	I For more information see chapter "SDI Sync Ref In" on page 44. and "Video Settings" on page 90.
12	SFP+ port (4)	N/A	In-/Output of digital video signals For more information see chapter "In-/Output of Digital Video Signals" on page 45.
13	HD-BNC connector	N/A	Downconvert video output For more information see chapter "SDI Sync Ref In" on page 44.
14	OCP NIC ports (optional)		Two 10 Gbps SFP+/10 GbE T connectors. For more information see "Network Interface (NIC) Connectors" on page 49.
15	NIC ports		Two 1 Gbps NIC connectors. For more information see "Network Interface (NIC) Connectors" on page 49.

## LTC In/Out

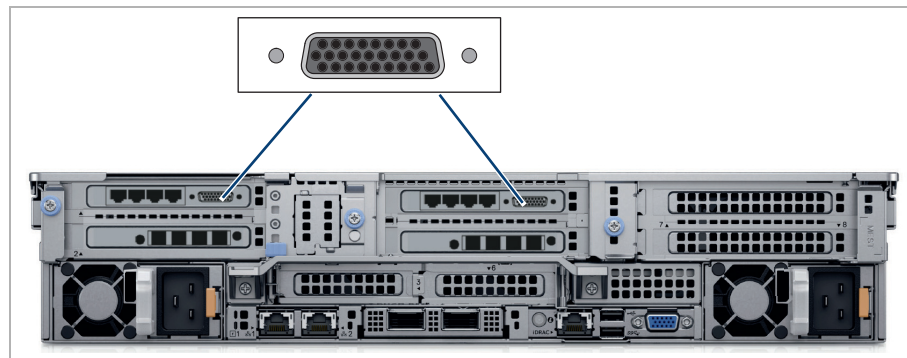

*HD Sub-D connector*

Besides the timecode options which are described in chapter "Timecode" on page 31 R&S VENICE S G3 gives you the possibility to use LTC timecode on each channel for ingest and playout. Receive or provide LTC timecode with the supplied Lynx cable (see chapter "Lynx CBL-AES1604 Cable" on page 59).

Via the R&S<sup>®</sup> Device Manager it's possible to assign LTC timecode that is received by one channel to all other channels.

The Rear of the System

### Power Supply Unit

Your system supports two 1100 W multi range PSUs (100 - 240 VAC).

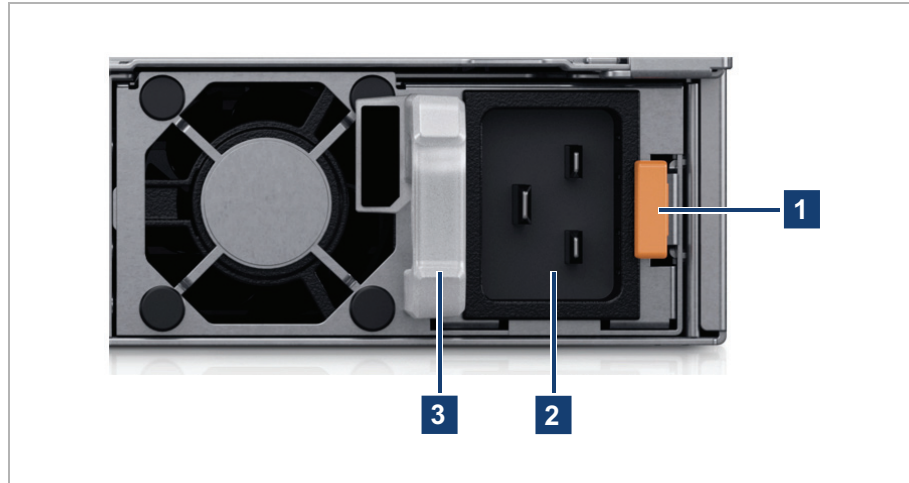

Power supply unit

1	Release latch
2	Power connector
3	PSU handle / Status indicator

### PSU Status Indicator Codes



PSU status indicator codes

	Status	Condition
<b>A</b>	Green	A valid power source is connected to the PSU and the PSU is operational.
<b>B</b>	Flashing green	When the firmware of the PSU is being updated, the PSU handle flashes green.
<b>C</b>	Flashing green and turns off	When hot-adding a PSU, the PSU handle flashes green five times at 4 Hz rate and turns off. This indicates a PSU mismatch concerning efficiency, feature set, health status, and supported voltage.
<b>D</b>	Flashing amber	Indicates a problem with the PSU.

For more information about removing and installing a PSU see chapter “Replacing a Power Supply Unit” on page 158.

## Out- or Input of Primary/Secondary Control Signals

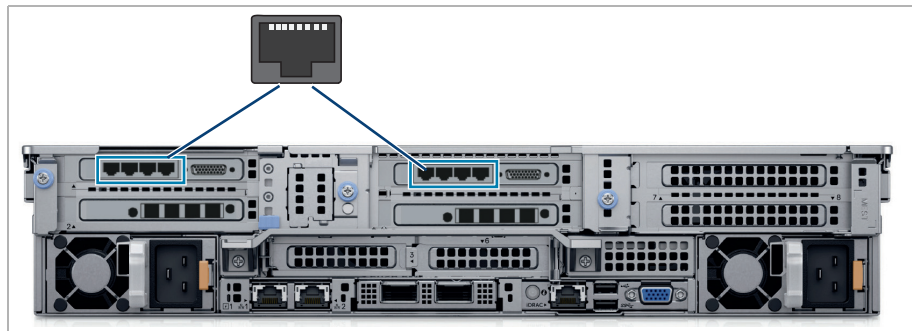

*RJ45 connector*

During a standard operation the pin-outs of the RJ45 connector are adjusted to secondary control mode. To use the full functionality of this connector you have to use the supplied adapter cable. For more information about the cable see chapter “Adapter Cable” on page 57. For the pin assignment see chapter “RJ45 Connector” on page 56.

With software version 4 in normal operation R&S VENICE S G3 is in secondary control mode. With software version 3.5 it is possible to change between primary and secondary mode in the R&S VENICE UI software.

## Downconvert Video Output

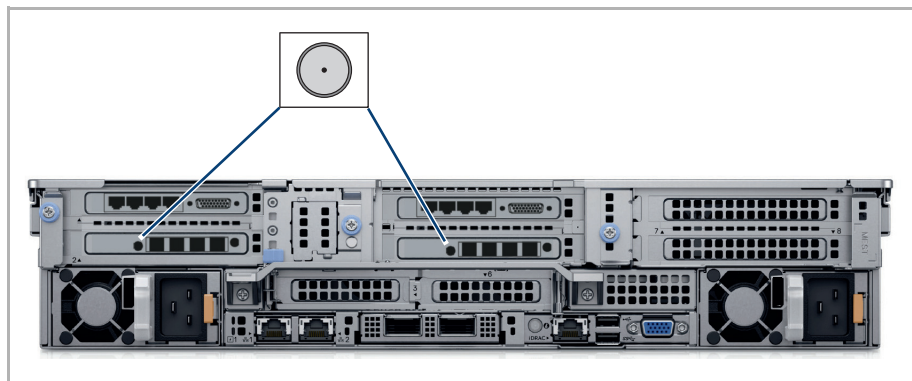

*HD-BNC connector*

The downconvert video output can be used for HD monitoring while the system is configured for UHD operation. The downconvert functionality is only active with UHD or 4K rasters. If enabled the UHD material will be send via the SDI outputs (1 channel operation) and the HD material via the downconvert output. In principle the signal is suitable for broadcast operations (e.g. Simulcast Payout). Please note the following restrictions.



Ingest signals (e.g. ingest of external satellite feeds), which are asynchronously to the output can cause frame repetitions or drop frames.

## The Rear of the System



Compared to the UHD output the downconvert output is delayed by a number of frames.

## Standard Conversion



The frame rate of the downconvert output must be either the same as the frame rate of the UHD raster or a multiple of it.

Output for 2160p50 Input:

- 576i50<sup>1</sup>
- 720p50
- 1080p25<sup>2</sup>
- 1080psf25<sup>2</sup>
- 1080i50
- 1080p50

Output for 2160p59,94 Input:

- 480i59,94<sup>1</sup>
- 720p59,94
- 1080p29,97<sup>2</sup>
- 1080psf29,97<sup>2</sup>
- 1080i59,94
- 1080p59,94

<sup>1</sup> Each full p frame will be converted to a single field in alternating order. All original motion phases will be kept during this conversion. Due to the enormous scaling factor from SD to UHD this conversion might lead to aliasing.

<sup>2</sup> This conversion skips every second original frame resulting in a reduction of temporal resolution.

## SDI Sync Ref In

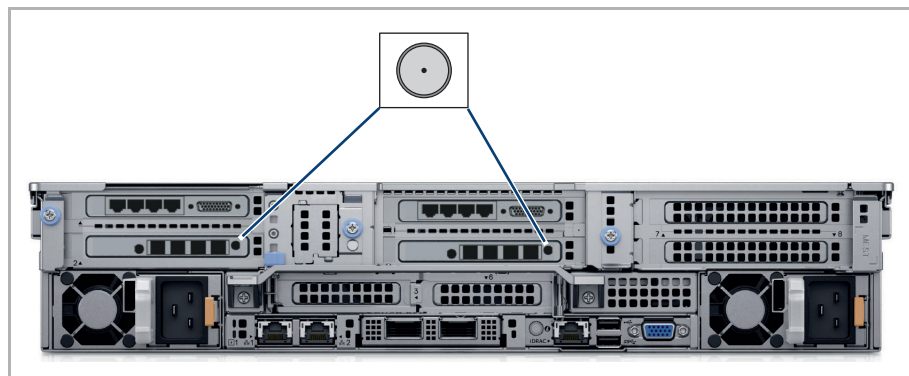

HD-BNC connector



This connector is used to distribute a master timing reference to all the equipment in a studio ecosystem. This guarantees that all the sources run at exactly the same frame rate and start the frames at the same instant. The sync ref settings are done in the R&S® Device Manager, see "Video Settings" on page 90.

### In-/Output of Digital Video Signals

The SFP+ ports are used for an in-/output of single-link and/or quad-link SDI video signals in 1.5G, 3G, 6G, and 12G.

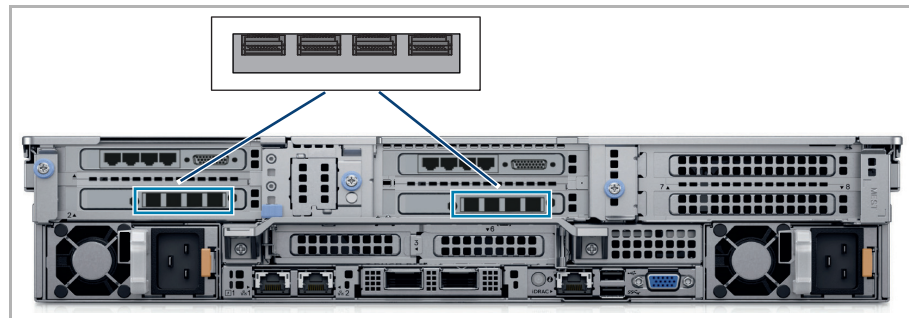

To use the functionality you have to insert the dual receiver and the dual transmitter into the SFP+ ports. For more information see chapter "Installing the System" on page 72.



Use only original Rohde & Schwarz certified parts.

### Channel Assignment

There are two configuration options depending on whether the system is equipped with 12G-capable SFP modules or only 3G modules are available.

#### 3G Configuration Option



3G SDI SFP coaxial dual transmitter



3GSDI SFP coaxial dual receiver

The Rear of the System

With the 3G configuration option all installed SFP modules are 3G-capable only. Higher input/output modes such as 6G and 12G are also available, however only in quad link mode.

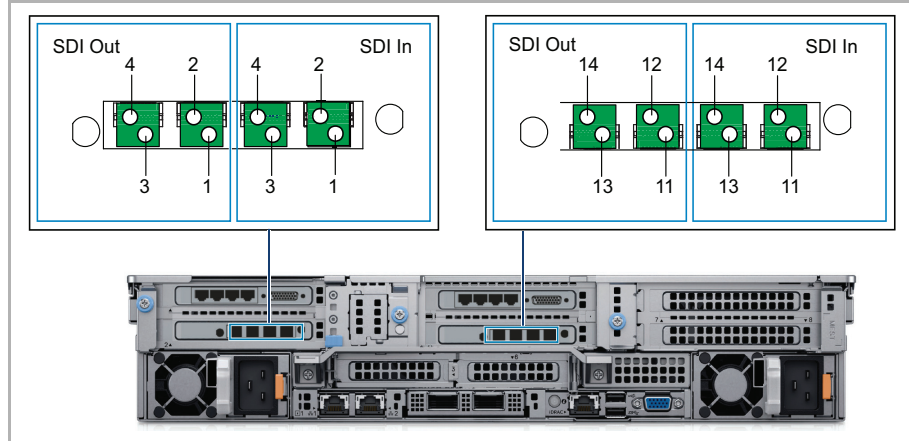

3G Configuration

You can use any of the channels in single link mode (1.5G or 3G). For quad link mode use 1 - 4 (and respectively 11 - 14) to form a quadrant, i.e. 1.5G x 4 for 6G, or 3G x 4 for 12G.

**12G Configuration Option:**



12G SDI SFP coaxial dual transmitter

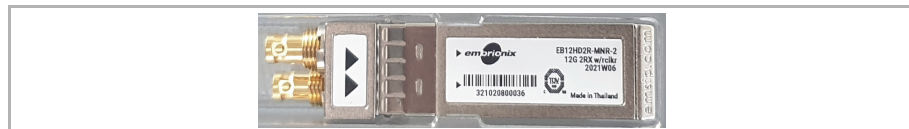

12GSDI SFP coaxial dual receiver

In 12G mode, every other module is 12G-capable whereas the rest of the installed modules are still 3G:

The Rear of the System

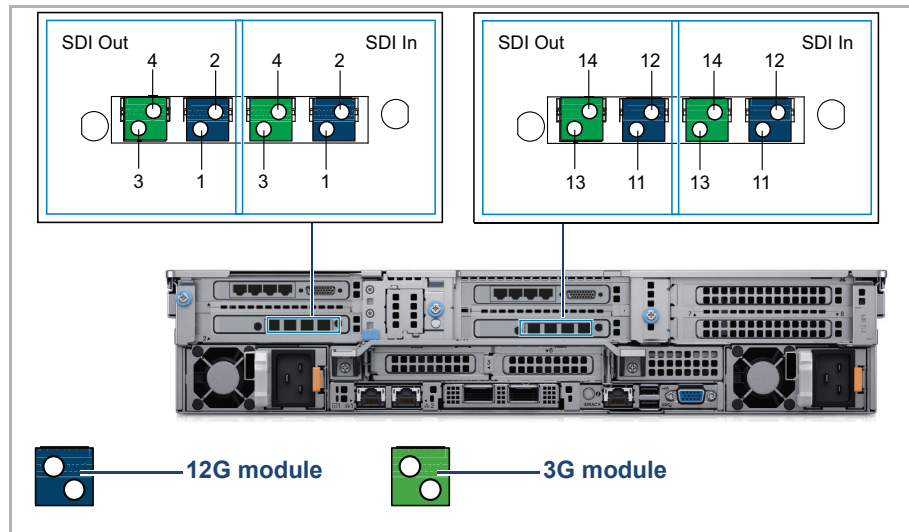

12G Configuration



In 12G configuration mode, channel 1 (and channel 11 respectively) are reserved for 12G single link operation. The rest of the channels can still be used in combination to form other input/output modes similar to the 3G configuration option.

The desired output mode is set in the VENICE UI software via the context menu of the associated channel ("Video settings" > "Playout" > "Output link").

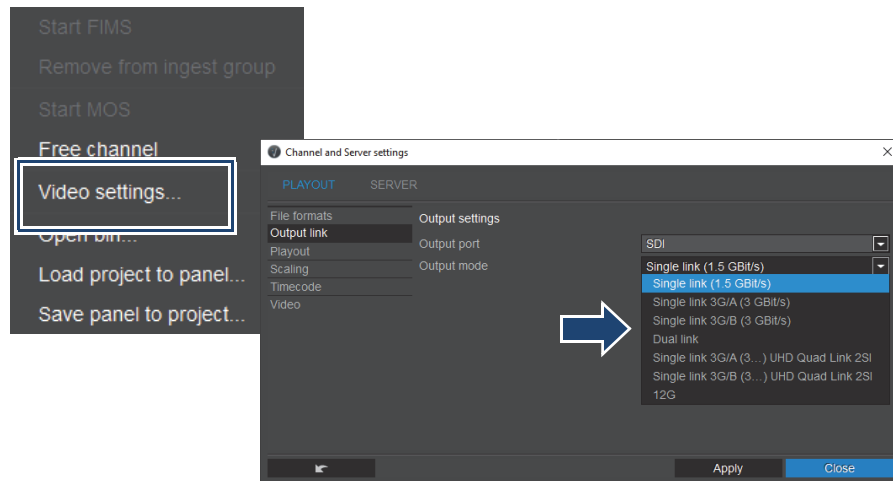

## The Rear of the System

## Video I/O Formats

## SDI 270 Mb/s Single Link

Standard	Raster	Framerate	Cabling per channel
SMPTE 259M	525i	29.97 fps	1x SDI 1.5G
SMPTE 259M	625i	25 fps	

## SDI 1.5G Single Link

Standard	Raster	Framerate	Cabling per channel
SMPTE 274M	1080i, 1080p, 1080PsF	25 fps, 29.97 fps	1x SDI 1.5G
SMPTE 296M	720p	25fps, 29.97fps, 50fps, 59.94fps	

## SDI 3G Single Link (Level a or B)

Standard	Raster	Framerate	Cabling per channel
SMPTE 425	1080p	50fps, 59.94fps	1x SDI 3G

## SDI 6G Single Link

Standard	Raster	Framerate	Cabling per channel
SMPTE 2081	2160p	25fps, 29.97fps	1 x SDI 6G on 12G modules (port 1 or 11 only)

## SDI 12G Single Link

Standard	Raster	Framerate	Cabling per channel
SMPTE 2082	2160p	50fps, 59.94fps	1 x SDI 12G (port 1 or 11 only)

### Network Interface (NIC) Connectors

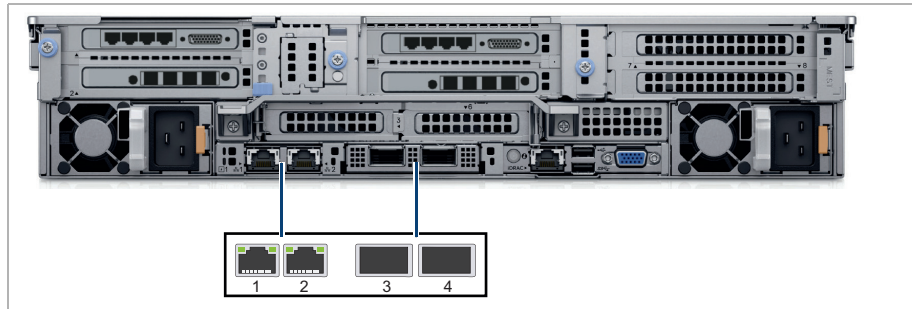

Ethernet connectors

	Port	Configuration	Speed
1	eno8303	DHCP	1 Gbps RJ45
2	eno8403	static IP address: 10.0.0.8	1 Gbps RJ45
3	eno12399	unconfigured	10 Gbps SFP+
4	eno12409	unconfigured	10 Gbps SFP+

### NIC Indicator

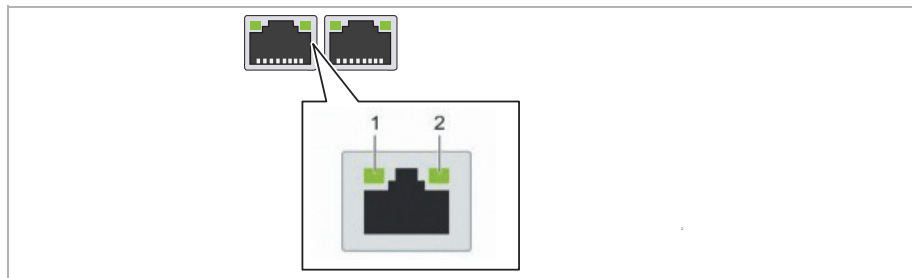

NIC indicator

1	Link indicator
2	Activity indicator

### NIC Indicator Codes



NIC indicator codes

	Status	Condition
A	Link and activity indicators are off	The NIC is not connected to the network.
B	Link indicator is green	The NIC is connected to a valid network at its maximum port speed (1 Gbps or 10 Gbps).

## The Rear of the System

<b>C</b>	Link indicator is amber	The NIC is connected to a valid network at less than its maximum port speed.
<b>D</b>	Activity indicator is flashing green	Network data is being sent or received.

## Inside the System

To get access to different components for example to replace a cooling fan you have to remove the system cover.

### System Cover

The system cover protects the components inside the system. Removing the system cover actuates the intrusion switch which aids in maintaining system security.

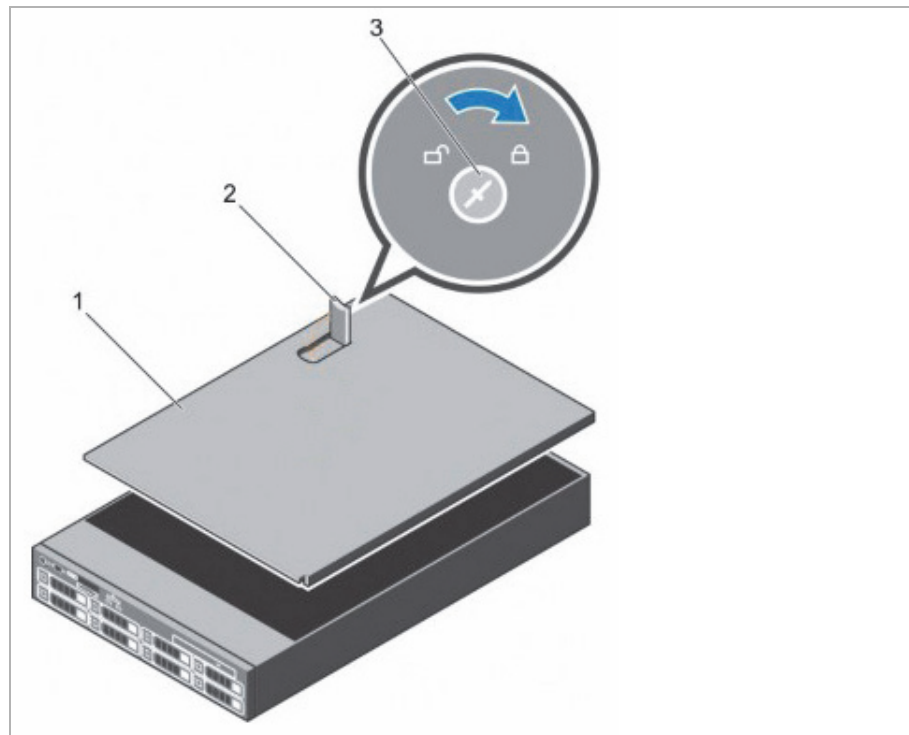

*System cover*

1	System cover
2	Latch
3	Latch release lock

For more information about opening and closing the system cover see chapter “Removing the System Cover” on page 156 and chapter “Installing the System Cover” on page 156.

## Cooling Fan Assembly

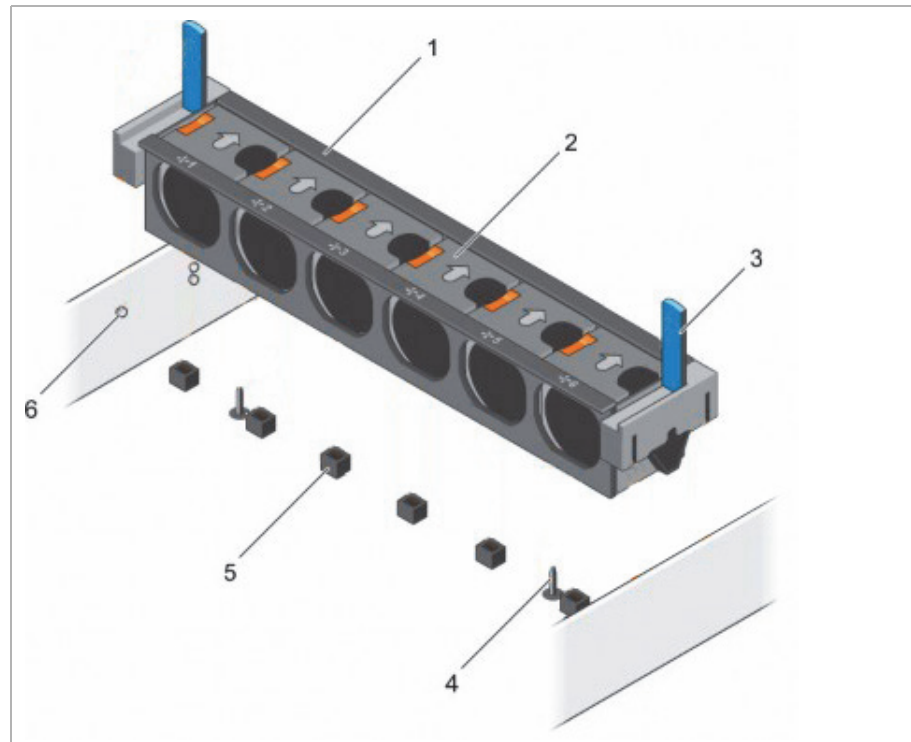

*Cooling fan assembly*

1	Cooling fan assembly
2	Cooling fan (6)
3	Release lever (2)
4	Guide pin on the system board (2)
5	Cooling fan connector (6)
6	Guide pin on the chassis (6)

The cooling fan assembly is an essential part of a server's cooling system. It ensures that the key components of the server such as the processors, hard drives, and memory get adequate air circulation to keep them cool. A failure in the server's cooling system can result in the server overheating and may lead to damage.

For more information about removing and installing the cooling fan assembly see chapter "Replacing a Cooling Fan Assembly" on page 162.



## Cooling Fans

Your system supports six hot-swappable cooling fans.

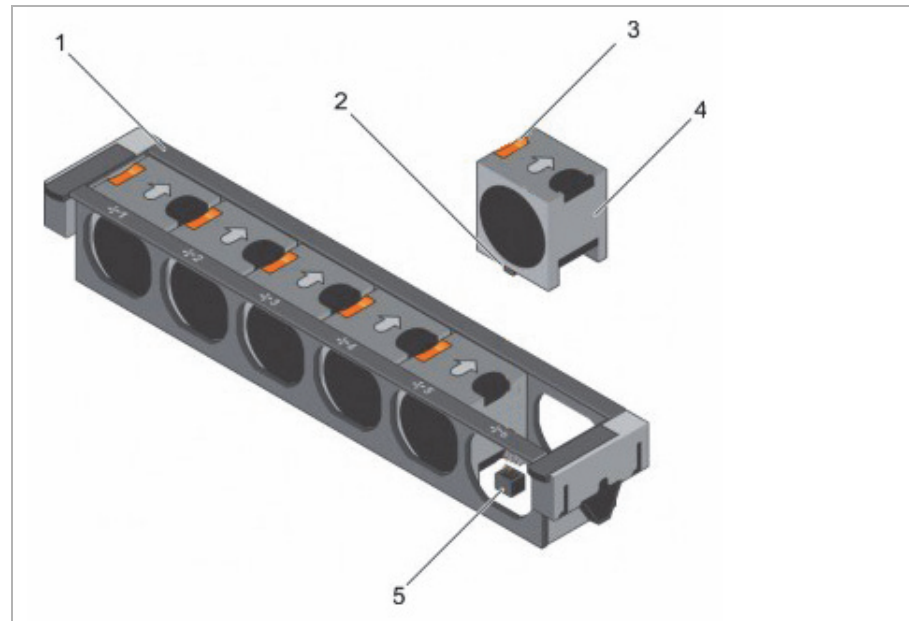

Cooling fans

1	Cooling fan assembly
2	Cooling fan connector (6)
3	Fan release tab (6)
4	Cooling fan (6)
5	Cooling fan connector on the system board (6)



In the event of a problem with a particular fan, the fan number is referenced by the R&S<sup>®</sup> Device Manager, allowing you to easily identify and replace the proper fan by noting the fan numbers on the cooling fan assembly.

For more information about removing and installing a cooling fan see chapter “Replacing a Cooling Fan” on page 163.

## Rescue Stick

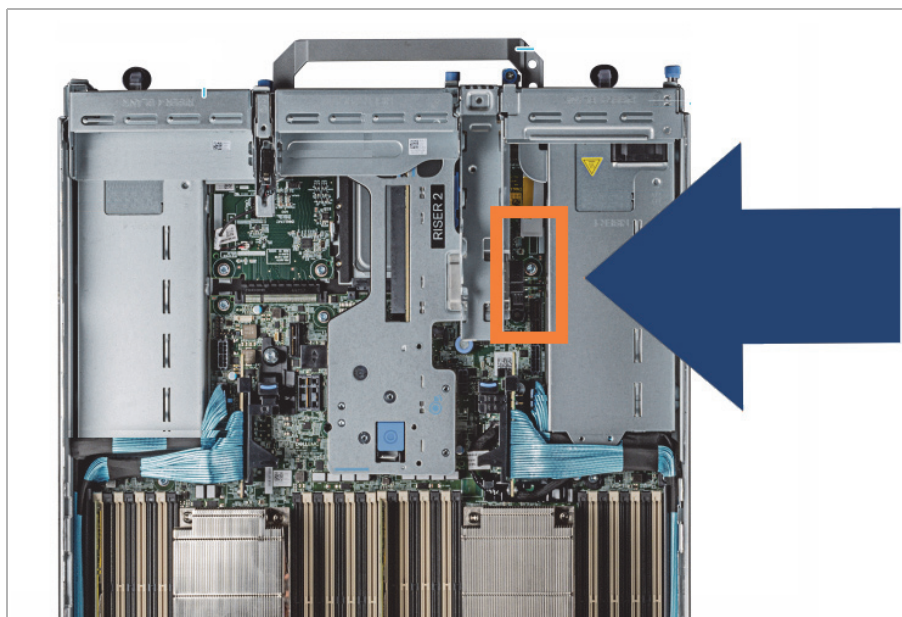

*Rescue stick*

The VENICE contains an internal USB flash drive that can be used to restore the operating system on the system disk back to its manufacturing state. Further information you will find in chapter “Replacing the Internal USB Memory Key” on page 165, chapter “Creating a Backup Image” on page 99 and chapter “Restoring the System” on page 102.

## Pin Assignment

### HD Sub-D Connector (LTC In/Out)

The HD Sub-D Connector enables you to use LTC In/Out. For all necessary information see chapter “LTC In/Out” on page 41 and information about the cable available in chapter “Lynx CBL-AES1604 Cable” on page 59.

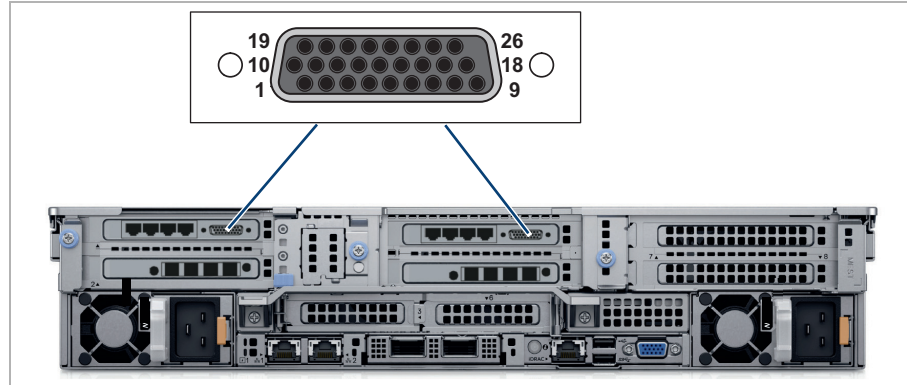

HD Sub-D connector (external view on device [female])

Pin No.	Signal	Pin No.	Signal
1	GROUND	14	OUT1 N
2	OUT4 N	15	IN4 P
3	GROUND	16	IN3 N
4	OUT2 N	17	IN2 P
5	GROUND	18	IN1 N
6	IN4 N	19	GROUND
7	GROUND	20	OUT3 P
8	IN2 N	21	GROUND
9	GROUND	22	OUT1 P
10	WORDCLOCK OUT	23	GROUND
11	OUT4 P	24	IN3 P
12	OUT3 N	25	GROUND
13	OUT2 P	26	IN1 P

Pin Assignment

**RJ45 Connector**

The RJ45 connector enables you to use Primary/Secondary control. For more information see chapter “Out- or Input of Primary/Secondary Control Signals” on page 43.

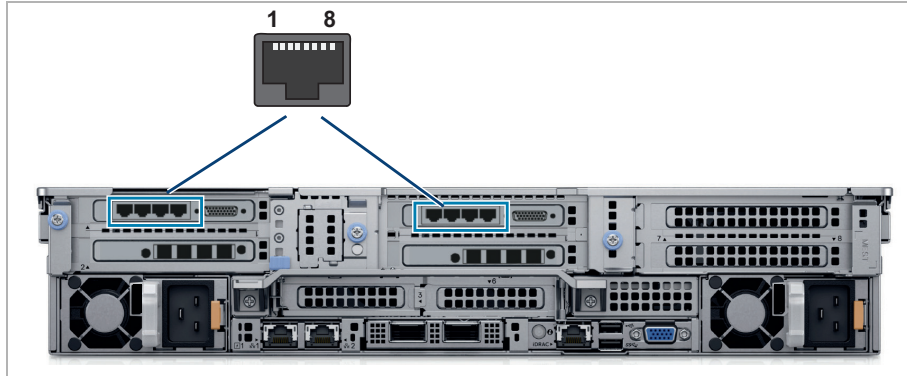

*RJ45 connector, serial RS-422 interface (4) (external view on device [female])*

RJ45 Pin No.	Secondary Mode (default) Signal	Primary Mode Signal
1	GND	GND
2	reserved	reserved
3	RX (+)	TX (+)
4	TX (-)	RX (-)
5	TX (+)	RX (+)
6	RX (-)	TX (-)
7	not connected	not connected
8	not connected	not connected



If you want to manufacture a direct line VDCP cable please note the secondary mode assignment above. Your VDCP cable should connect the automation’s TX+/- pins with the RX+/- pins of the R&S VENICE S G3 and vice versa (+ to + and - to - and of course GND/ground).

### Video Connector

The VGA port enables you to connect a VGA display to the system.

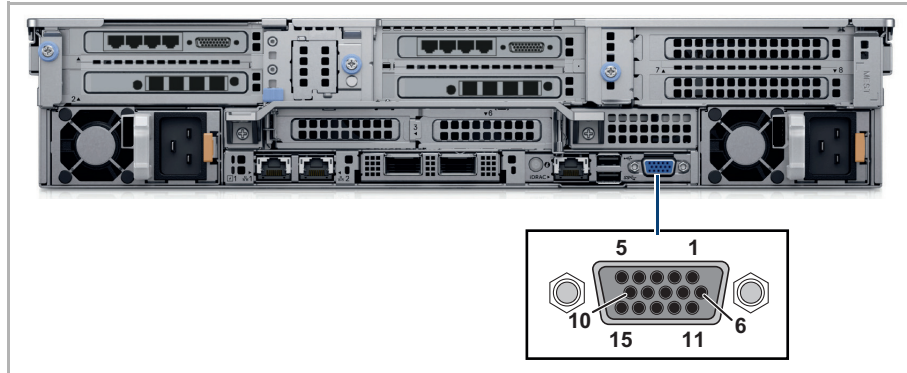

DB-15 connector (external view on device [female])

Pin No.	Signal	Pin No.	Signal
1	RED	9	KEY
2	GREEN	10	SGND
3	BLUE	11	ID0
4	ID2	12	ID1 or SDA
5	GND	13	HSYNC or CSYNC
6	RGND	14	VSYNC
7	GGND	15	ID3 or SCL
8	BGND		

### Adapter Cable

With the adapter cable its possible to transfer the primary/secondary control signal. For more information see chapter “RJ45 Connector” on page 56.



RS-422 (RJ-45 [RIB7.0] male to D-Sub 9

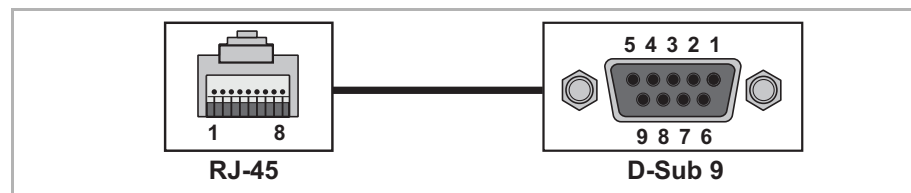

RS-422 (RJ45 [RIB7.0] male to D-Sub 9 female, external view)

## Pin Assignment

RJ45 Pin No.	Secondary Mode (default) Signal	Primary Mode Signal	D-Sub 9 Pin No.
1	GND	GND	4, 6
2	reserved	reserved	5
3	RX (+)	TX (+)	3
4	TX (-)	RX (-)	2
5	TX (+)	RX (+)	7
6	RX (-)	TX (-)	8
7, 8	not connected	not connected	1, 9

Output		
RJ-45 Pin No.	Signal	D-Sub 9 Pin No.
3	TX (+)	3
6	TX (-)	8
5	RX (+)	7
4	RX (-)	2
1	Ground	4, 6
2	Reserved	5
7,8	not connected	1, 9

### Lynx CBL-AES1604 Cable

The Lynx CBL-AES1604 cable allows you to transfer an LTC in- and output signal for each channel. For more information see chapter “LTC In/Out” on page 41.



Lynx CBL-AES1604 cable

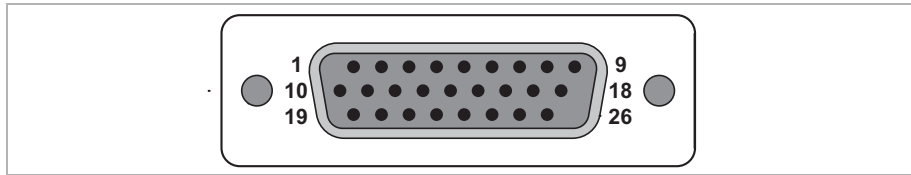

Lynx CBL-AES1604 cable (external view)

Pin No.	Signal	Pin No.	Signal
1	GROUND	14	OUT1 N
2	OUT4 N	15	IN4 P
3	GROUND	16	IN3 N
4	OUT2 N	17	IN2 P
5	GROUND	18	IN1 N
6	IN4 N	19	GROUND
7	GROUND	20	OUT3 P
8	IN2 N	21	GROUND
9	GROUND	22	OUT1 P
10	WORDCLOCK OUT	23	GROUND
11	OUT4 P	24	IN3 P
12	OUT3 N	25	GROUND
13	OUT2 P	26	IN1 P

## Network Ports

This section lists the default TCP and UDP ports used by both the R&S VENICE S G3 Server and the R&S VENICE S G3 Client. All ports are open by default.

The following topics are covered:

- VENICE S Server Ports (Information) (page 60)
- VENICE S Server Ports (Configuration) (page 64)
- VENICE S Client Ports (Information) (page 66)
- VENICE S Client Ports (Configuration) (page 68)

### VENICE S Server Ports (Information)

Port	Type	Direction	Info	Remarks
*	*	in & out	The built-in network adapters for ST2110 traffic are reserved for ST2110 only.	This is the dedicated audio/video interface for customers that want to use video connectivity via ST2110.
3702	UDP	in & out	WSDD service discovery	udp multicast to/from ip 239.255.255.250: In some versions this port can be configured in /etc/opt/rohde-schwarz/Venice/VeniceWebService.conf as entry WsddBroadcastPort (which is not present by default)
443	TCP	in	Device Manager	tcp / https service listening:  Standard web server for browser based configuration tool "Device Manager".  If accessing via insecure port 80, users are redirected to port 443 using secure http connection.
8070	TCP	in & out	Maintenance service	tcp / https service listening:  This interface controls overall VENICE server configuration and options



Port	Type	Direction	Info	Remarks
8111 – 8114, 8119 8121 - 8124, 8129	TCP	in & out	VDCP over IP	tcp service listening:  VDCP is an industry standard to control video tape devices. Originally implemented over a serial line (RS422), this implementation offers VDCP over a socket connection. One port per logical video channel on the VENICE device.
8011 – 8014, 8019, 8021 – 8024, 8029	TCP	in	VENICE web service, FIMS, MOS	tcp/http service listening:  The per-channel VENICE web services, offering control over the video server via the MOS and FIMS standards.
30001	UDP	in & out	SpycerNet service discovery	udp multicast to/from 239.255.0.1:  This port is used to find other spycer service for interoperation in the spycer network.
30002 – 40001	TCP	in & out	SpycerNet	tcp service listening on port, tcp clients connecting to other hosts on this port:  Spycer instances communicate using these ports, starting from 30002.
9983	TCP	in	SpycerCopy	tcp service listening:  dedicated port used to transfer files.
8010	TCP	in	Spycer web service	tcp/http service listening:  Spycer offers its operations to automations / spycer client.
161 162	UDP	in out	SNMP and SNMP Traps	udp listening on ports udp sending to ports  snmp communication. SNMP is a protocol to monitor network activity.
8093	TCP	in	Workflow engine	tcp/http service listening:  The workflow engine can be configured and controlled by REST requests to this port.

## Network Ports

Port	Type	Direction	Info	Remarks
4224	TCP	in & out	Virtual Storage Access (VSA)	tcp service listening and connecting to other tcp services on this port.
4225	UDP	in & out	Virtual Storage Access (VSA)	udp multicast service listening
80, 443	TCP	in	iDRAC	DELL management. Use username "root" and the serial number of the system as password to log in. For systems built after April 2022 prepend "rs" to the beginning of the serial number (e.g "rs123456").
25, 587	TCP	out	E-mail notifications	E-mail notifications from RuS software
123	UDP	out (& in)	NTP	Listening on udp port for client requests  sending on other servers' udp port to fetch and negotiate current time.  depending on config
53	UDP/TCP	out	DNS	tcp/udp / DNS  asking other name servers to resolve host names.
22	TCP	in	SSH	tcp / ssl  Offering secure command line remote access.
137, 138, 139, 445	TCP	in & out	SMB	tcp listening:  Offering windows network shares  tcp connecting to other servers:  Accessing windows network shares hosted on different machines.

Port	Type	Direction	Info	Remarks
20, 21	TCP	in & out	FTP	<p>tcp listening on 21:</p> <p>Offering ftp (file transfer) service and passive ftp transfer.</p> <p>tcp connecting FROM port 20 to random client port as offered by client: active ftp transfer (as legacy mode of operation).</p>
2049, 111	UDP/TCP	in & out	NFS (Other ports might be required, too)	<p>tcp and/or udp server listening and / or connecting to other server.</p> <p>Actual port usage highly depends on actual configuration on client-side.</p>
5960 - 5970	TCP	in	VENICE Video overlay streaming	
5353	UDP	in & out	VENICE NDI: Service discovery	Multicast, mDNS
4711 - 4714, 4719 4721 - 4724, 4729	TCP	in	VENICE NDI: Overlay streaming	
5960	TCP	in	VENICE NDI: General communication	<p>tcp service listening:</p> <p>Stream catalogue of NDI streams</p>
5961 - 5970	TCP	in	<p>NDI: Communication</p> <p>One port per overlay channel (in random order, so channel 1 is not always on 5961)</p>	<p>depending on configuration:</p> <p>when using TCP:</p> <p>tcp service listening: One port per overlay channel (in random order, so channel 1 is not always on 5961)</p> <p>when using UDP: udp service listening and pushing packets from this port.</p>
6960 - 6969	TCP/UDP	in & out	VENICE NDI: Video Streaming	<p>depending on configuration:</p> <p>Receiving NDI data.</p>
7960 - 7969	TCP/UDP	in & out	VENICE NDI: Video streaming	<p>depending on configuration:</p> <p>Sending NDI data.</p>

## Network Ports

Port	Type	Direction	Info	Remarks
8031	TCP	in	RuS Installation service (RSI)	tcp service listening:  Receiving orders to install an RSI.
13217	TCP/UDP	in & out	RuS Installation service (RSI)	

## VENICE S Server Ports (Configuration)

Port	NIC	Multicast	Protocol	Configurable	Config recommended
*	ST2110 NIC names dynamically		ST2110	no	
3702	primary (eno8303)	239.255.255.250	http, XML	no	
443	primary (eno8303e no8303)		https	no	
8070	primary (eno8303)		http, SOAP	no	
8111 – 8114, 8119 8121 - 8124, 8129	primary (eno8303)		VDCP binary	no	
8011 – 8014, 8019, 8021 – 8024, 8029	primary (eno8303)		http, SOAP	no	
30001	primary (eno8303)	Spycer Multicast IP (239.255.0.1)	propri- etary, encrypted	/etc/opt/rohde- schwarz/Spycer/IP.c onf	No, not a user- visible feature
30002 – 40001	primary (eno8303)		propri- etary, encrypted	/etc/opt/rohde- schwarz/Spycer/IP.c onf	No, not a user- visible feature
9983	primary (eno8303)		binary	no	
8010	primary (eno8303)		http, SOAP	no	
161 162	primary (eno8303)				
8093	primary (eno8303)		http, REST	no	

Port	NIC	Multicast	Protocol	Configurable	Config recommended
4224				/etc/opt/rohde-schwarz/BfsSyncD/bfs-syncd.conf and/or /etc/opt/rohde-schwarz/Bfs/bfs.conf	No, not a user-visible feature.
4225		VSA multicast IP 239.192.42.23		/etc/opt/rohde-schwarz/BfsSyncD/bfs-syncd.conf and/or /etc/opt/rohde-schwarz/Bfs/bfs.conf	No, not a user-visible feature.
80, 443	iDRAC socket		http, (https)		
25, 587	primary (eno8303)		smtp, smtps		
123	primary (eno8303)		NTP	/etc/ntp.conf	No, not a user-visible feature
53	primary (eno8303)		DNS		no
22	primary (eno8303)		SSH	/etc/sshd/sshd.conf	No, not a user-visible feature
137, 138, 139, 445	primary (eno8303)		SMB		no
20, 21	primary (eno8303)		FTP	/etc/vsftpd/	No, not a user-visible feature
2049, 111	primary (eno8303)				
5960 - 5970	primary (eno8303)		NDI	no	Configuration not possible by user
5353	primary (eno8303)	224.0.0.251	mDNS	no	Configuration not possible by user
4711 - 4714, 4719 4721 - 4724, 4729	primary (eno8303)		NDI	no	Configuration not possible by user
5960	primary (eno8303)		NDI	no	Configuration not possible by user
5961 - 5970	primary (eno8303)		NDI	no	Configuration not possible by user
6960 - 6969	primary (eno8303)		NDI	no	Configuration not possible by user
7960 - 7969	primary (eno8303)		NDI	no	Configuration not possible by user

## Network Ports

Port	NIC	Multicast	Protocol	Configurable	Config recommended
8031	primary (eno8303)		http	no	
13217	primary (eno8303)		proprietary	no	

## VENICE S Client Ports (Information)

Port	Type	Direction	Info	Remarks
3702	UDP	out	WSDD service discovery	udp multicast to/from ip 239.255.255.250:
443	TCP	out	Device Manager	using VENICE tcp / https service:  Accessing standard web server for browser based configuration tool "Device Manager".  If accessing via insecure port 80, users are redirected to port 443 using secure http connection.
8070	UDP	in	Maintenance service	using VENICE tcp / https service:  This interface controls overall VENICE server configuration and options.
8011 – 8014, 8019, 8021 – 8024, 8029	TCP	in	VENICE web service, FIMS, MOS	using VENICE tcp/http service:  The per-channel VENICE web services, offering control over the video server via the MOS and FIMS standards.
30001	UDP	in & out	SpycerNet service discovery	udp multicast to/from 239.255.0.1:  This port is used to find other spycer service for interoperation in the spycer network.

Port	Type	Direction	Info	Remarks
30002 - 40001	TCP	in	SpycerNet	tcp service listening on port, tcp clients connecting to other hosts on this port:  Spycer instances communicate using these ports, starting from 30002.
9983	TCP	in	Spycer copy	tcp service listening:  dedicated port used to transfer files.
8010	TCP	in	Spycer web service	tcp/http service listening:  Spycer offers its operations to automations / spycer client.
8093	TCP	in	Workflow engine	using VENICE tcp/http service:  The workflow engine can be configured and controlled by REST requests to this port.
5960 - 5970	TCP	in	VENICE Video overlay streaming	
5353	UDP	in & out	VENICE NDI: Service discovery	Multicast, mDNS
4711 - 4714, 4719 4721 - 4724, 4729	TCP	in	VENICE NDI: Overlay streaming	
5960	TCP	in	VENICE NDI: General communication	tcp service listening:  Stream catalogue of NDI streams
5961 - 5970	TCP	in	VENICE NDI: Communication	depending on configuration:  when using TCP:  tcp service listening: One port per overlay channel (in random order, so channel 1 is not always on 5961)  when using UDP: udp service listening and pushing packets from this port.
6960 - 6969	TCP/UDP	in & out	VENICE NDI: Video streaming	depending on configuration:  Receiving NDI data.

## Network Ports

Port	Type	Direction	Info	Remarks
7960 - 7969	TCP/UDP	in & out	VENICE NDI: Video streaming	depending on configuration: Sending NDI data.
8031	TCP	out	RuS Installation service (RSI)	using VENICE tcp service: Sending orders to install an RSI.
13217	TCP/UDP	in & out	RuS Installation service (RSI)	

## VENICE S Client Ports (Configuration)

Port	NIC	Multicast	Protocol	Configurable	Config recommended
3702	primary (eno8303)	239.255.255.250	http, XML	no	
443	primary (eno8303)		https	no	
8070	primary (eno8303)		http, SOAP	no	
8011 – 8014, 8019, 8021 – 8024, 8029	primary (eno8303)		http, SOAP	no	
30001	primary (eno8303)	Spycer Multicast IP (239.255.0.1)	proprietary, encrypted	/etc/opt/rohde-schwarz/Spycer/IP.conf	No, not a user-visible feature
30002 - 40001	primary (eno8303)		proprietary, encrypted	/etc/opt/rohde-schwarz/Spycer/IP.conf	No, not a user-visible feature
9983	primary (eno8303)		binary	no	
8010	primary (eno8303)		http, SOAP	no	
8093	primary (eno8303)		http, REST	no	
5960 - 5970	primary (eno8303)		NDI	no	Configuration not possible by user
5353	primary (eno8303)	224.0.0.251	mDNS	no	Configuration not possible by user
4711 - 4714, 4719, 4721 - 4724, 4729	primary (eno8303)		NDI	no	Configuration not possible by user



Port	NIC	Multicast	Protocol	Configurable	Config recommended
5960	primary (eno8303)		NDI	no	Configuration not possible by user
5961 - 5970	primary (eno8303)		NDI	no	Configuration not possible by user
6960 - 6969	primary (eno8303)		NDI	no	Configuration not possible by user
7960 - 7969	primary (eno8303)		NDI	no	Configuration not possible by user
8031	primary (eno8303)		http	no	
13217	primary (eno8303)		proprietary	no	

Network Ports

# Installation and Configuration

This chapter is divided into the following sections:

- "Installing the System" (page 72)
- "Starting the System" (page 76)
- "Configuring the System" (page 77)
- "Shutting Down the System" (page 79)

## Installing the System

Perform the following steps:

1. Unpack the R&S VENICE S G3 system and its accessories.

---

**NOTICE****Warranty Claims**

To make warranty claims you have to keep the original packing and use it in case of a return transportation.

---

2. Check your delivery and compare it with the delivery note. In case of missing items, contact your local vendor or Rohde & Schwarz immediately.

---

**⚠ DANGER****Source of Danger**

Improper handling of the VENICE S can cause substantial damage to personnel and equipment by falling or overturning.

**VENICE S must be lifted and carried by two people on both sides. It is preferable to use lifting devices and means of transport. Beware of the crushing hazard when working with heavy loads.**

---

3. Place the system on a firm, flat surface within reach of a power outlet or mount it in a rack. For proper air circulation and cooling make sure the ventilation holes on the rear of the system are not covered.

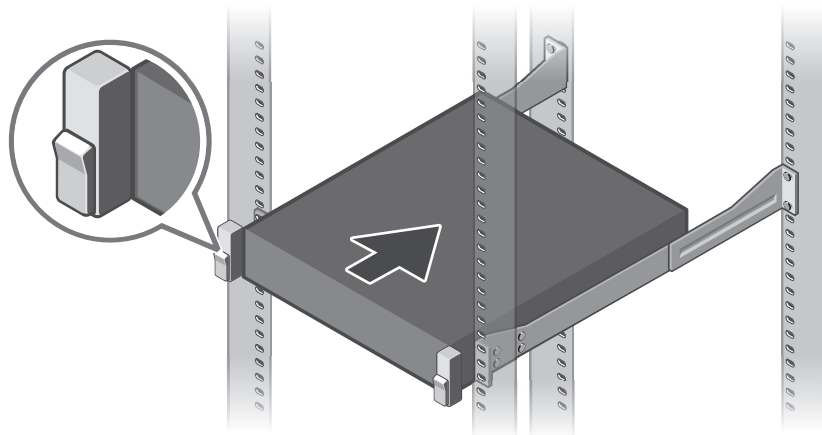

**NOTICE****Environmental Conditions**

For error-free working and a long service life of **R&S VENICE S G3** observe the following basic environmental conditions:

- Do not expose R&S VENICE S G3 to sources of heat, such as direct sunlight or a radiator.
- Do not cover or obstruct the ventilation holes of the system. When installing the system in a rack, take care that warmed up air is conducted to the rear of the rack and properly vented away.
- Avoid areas with high humidity or dust. Best operating conditions are given in an air-conditioned site.
- Do not expose R&S VENICE S G3 to strong electric or magnetic fields.
- Avoid areas where R&S VENICE S G3 will be subject to vibrations or shocks.

4. If necessary connect the following computer peripherals:

- Mouse
- Keyboard
- Monitor

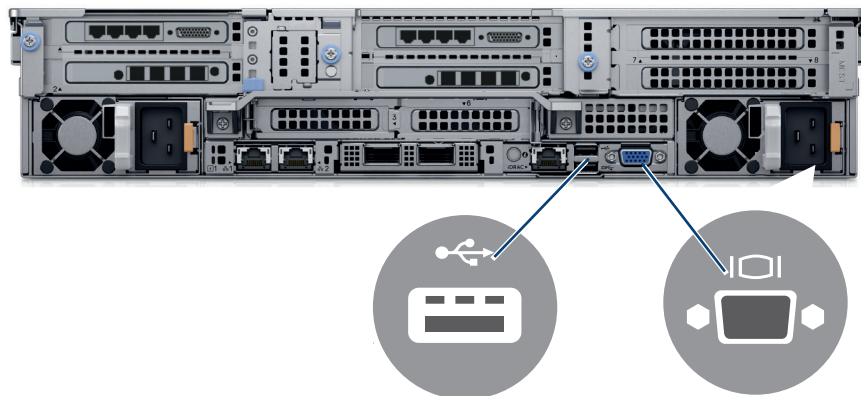

5. Connect the system to a power source.

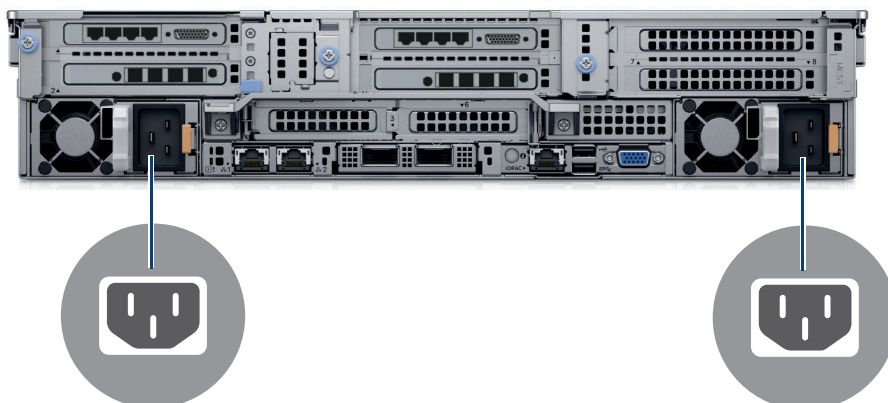

**NOTICE****Data Loss/Corrupt Data**

In the event of a power failure the device will be abruptly switched off. This can result in corrupt data, loss of data, and equipment damage.

**Connect the system to an uninterruptible power supply (UPS) redundantly on two phases.**

6. Loop and secure the power cable using the retention strap.

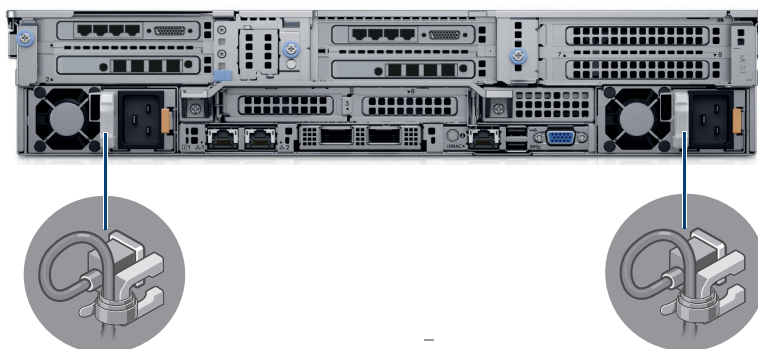

7. Connect a network cable to the Ethernet connector “eno8303” or “eno8403” depending on your installation routine. For details see chapter “Network Configuration” on page 77.

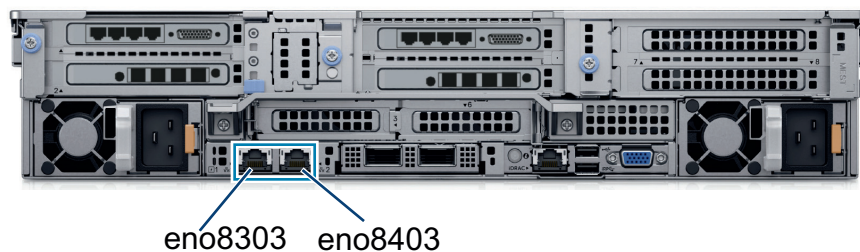

- ▶ With “eno8303” the IP address is assigned automatically. With “eno8403” the default IP is **10.0.0.8**.



Use only original Rohde & Schwarz certified parts.

8. Insert the supplied SDI SFP coaxial dual transmitter (arrows point outwards) and the SDI SFP coaxial dual receiver (arrows point inwards) into the according SFP+ ports.

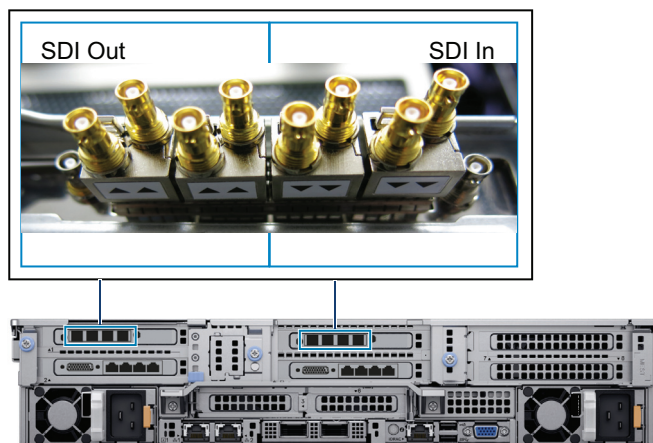

In case you are installing the 12G option, consult also section "Channel Assignment" on page 45 for the correct position of the SFP modules.

9. Connect the HD-BNC to BNC adapter cables to the SDI In/Out connectors.
10. Connect any other peripheral computer and video equipment. An overview of the panels and connectors are listed in chapter "The Rear of the System" on page 40.

R&S VENICE S G3 is ready for first use. The R&S VENICE S G3 hardware is now properly installed and you can switch on the system.

## Starting the System

## Starting the System

After a proper installation of the system you may start the R&S VENICE S G3 system at any time.

Perform the following steps:

- Press the power switch briefly to turn on the system.

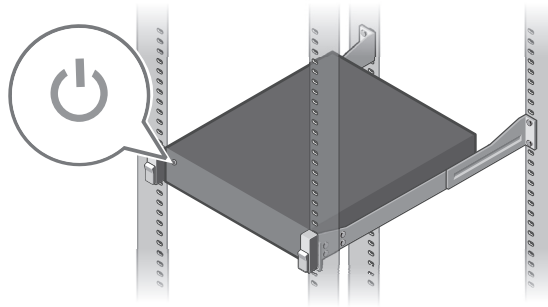

- ▶ The system will be started. It takes several minutes until the system is fully operational.

For the initial setup the device must be integrated into a network. If the IP of the device is already known a remote SSH terminal (e.g. Putty) can be used to make the basic configuration. Alternatively a monitor and keyboard can be temporarily connected on the front or on the rear of the system. Continue with chapter “Configuring the System” on page 77.



## Configuring the System

For the initial setup the device must be integrated into a network.

### Network Configuration

There are two ways for the network configuration. You can use a dynamic or a static IP address as described below. We recommend to use a static IP for the initial setup.

#### Using a Static IP

Perform the following steps:

1. Connect your laptop or PC directly to network interface "eno8403", see Network Interface (NIC) Connectors (page 49)
2. Configure your PC's/laptops network interface to a static IP address 10.0.0.8.
3. Open a SSH console to the IP 10.0.0.8.  
→ Alternatively you can use a local console with keyboard/mouse.
4. Log in as **root** with the following password: **[serial number of the device]**.
5. Edit the configuration file with:  
**vi /etc/sysconfig/network-scripts/ifcfg-eno8403**
6. Change line **IPADDR=10.0.0.8** into: **IPADDR= your new IP address**
7. Activate the new IP with:  
**systemctl restart network**

Now R&S VENICE S G3 is ready for integrating the software services.

#### Using a Dynamic IP

Perform the following steps:

1. Connect a cable from the network interface "eno8303".
2. Determine the dynamic IP address with the command:  
**ifconfig eno8303**

Now the dynamic IP address can be used for further configurations.

## Configuring the System

## Integrating Software Service

This setting configures which network interface the software uses for communication. In general this setting is already configured to use the interface “eno8303”. Only use the following steps if a different configuration is necessary.

Perform the following steps:

- Use the command `fbms-setup.sh -c [interface]` to integrate the software services on the network.  
e.g.: `fbms-setup.sh -c eno8403` (It's the most common use to change to port “eno8403” for static IP setups.)

After the command is executed the configuration is complete. R&S VENICE S G3 can immediately be operated by remote control from any Windows system connected to the same network.

## System Update

There is a factory created base image on the system disks that does not contain the latest VENICE software.

Perform the following steps:

- Follow the steps in chapter “System Update” on page 105.

You are in full operating state now and can configure the R&S VENICE S G3 and change it's operating modes (VDCP, MOS, FIMS) to demo all functionality with the available graphical clients.

## Management Tool R&S®Device Manager

As soon as you have the network up and running you can access the R&S®Device Manager from your PC/laptop for all kind of configuration and management. To get access to the R&S®Device Manager you have to enter the previously determined IP address in a standard browser (see chapter “Network Configuration” on page 77).

## Shutting Down the System

There are several possibilities to shut down the system. It depends on whether the operating system is already loaded, frozen or not completely loaded. Please act accordingly.

---

**NOTICE****Re-start**

It takes a while to safely erase all memory banks of the system.

After a shut-down wait at least ten seconds before starting the system again.

---

### Shut Down While Running

Perform the following steps:

- Enter **poweroff** in the command line of the R&S VENICE S G3.
  - ▶ The operating system will save your personal settings and once it has ended, the system will turn off.

System is shut down.

### Shut Down With Operating System Frozen or Not Completely Loaded

If the operating system is not responding anymore or not completely loaded, do as follows:

---

**NOTICE****Corrupted Data**

Shutting down the system while frozen or not completely loaded may lead to corrupted system data.

Use this procedure only if absolutely necessary.

---

Perform the following steps:

- Shut down the system by pressing the power switch lengthly until the system turns off.

The system is shut down.

Shutting Down the System

# Operation

This section describes how to operate R&S VENICE S G3.

The following topics are covered:

- "Usable Software and Protocols" (page 82)
- "VENICE UI" (page 83)
- "Playing Content" (page 84)
- "Ingesting Content" (page 85)
- "Transforming Content" (page 86)
- "File Management" (page 87)
- "Configuring VENICE S Services" (page 88)
- "Configuring the Subtitles" (page 92)

## Usable Software and Protocols

Module	Software / Protocol	
Ingest	VDCP	RS-422, TCP/IP
	R&S®VENICE UI	
	FIMS capture	SOAP
Playout	VDCP	RS-422, TCP/IP
	R&S®VENICE UI	
	MOS	SOAP
Transform	R&S®VENICE UI	
	FIMS transform	SOAP

## VENICE UI

The R&S<sup>®</sup>VENICE UI software is the operator's interface to the video channels. With it the operator can connect to the server (i.e. to the VENICE server software) via network and allocate one of the video channels to control ingest, playout and transform operations. The R&S<sup>®</sup>VENICE UI software can be installed on any Windows network client for a remote control of the server. With one instance of the software you can control different video channels of one or more VENICE servers at the same time.

## Playing Content

The R&S®VENICE UI Payout Module is the operator's interface to the video channels to play content. With one instance of the software you can control different video channels of one or more VENICE servers at the same time.

In addition R&S VENICE S G3 supports MOS 3.8.4 using SOAP. By implementing MOS, Rohde & Schwarz has opened and simplified the integration of the VENICE S.

Furthermore R&S VENICE S G3 with software is VDCP compliant. This proprietary communications protocol primarily is used in broadcast automation to control broadcast devices, like video servers for broadcast television. The serial communications protocol based on RS-422 is derived from the Sony 9-Pin protocol, an industry-standard protocol for controlling professional broadcast VTRs.

VENICE S uses the tightly coupled primary-secondary methodology of VDCP. The controlling device takes the initiative in communications between the controlling broadcast automation device and the controlled device (video disk). VDCP conforms to the Open Systems Interconnection (OSI) reference model.

For more information see chapter "Configuring VENICE S Services" on page 88 and chapter "Out- or Input of Primary/Secondary Control Signals" on page 43.



## Ingesting Content

With R&S®VENICE UI you can connect to the server via network and control single and multi channel ingest operations. With one instance of the software you can control different video channels of one or more VENICE servers at the same time.

Furthermore VENICE S supports FIMS capture using SOAP. Rohde & Schwarz has chosen to implement the FIMS protocol as the primary method by which machines may access their devices and consume their services.

For more information see chapter “Configuring VENICE S Services” on page 88.

## Transforming Content

With R&S®VENICE UI it is possible to control transform jobs and you can use FIMS as well. For more information see chapter “Configuring VENICE S Services” on page 88.

## File Management

The innovative data and content control software R&S®Spycer allows you to easily maintain transparency and control over video and audio data and their associated metadata. The software offers conclusive rights management, browsing, searching and viewing of video and audio material.

Rohde & Schwarz offers the Spycer functionality also via Spycer web service. For more information see chapter “Configuring VENICE S Services” on page 88.

## Configuring VENICE S Services

To use one of the mentioned methods on a R&S VENICE S G3 with you have to activate the respective function in the R&S®Device Manager. For more information about the different web services, VDCP as well as how to integrate and control R&S VENICE S G3 by third-party software see the Software Integration Guide. (available at <https://gloris.rohde-schwarz.com>)

### Activating and Launching VDCP

Perform the following steps:

1. Open the R&S®Device Manager on your local system. To get access to the R&S®Device Manager you have to enter the previously determined IP address and the port 3000 in a standard browser.
2. Select the **VENICE MEDIA SERVER** tab.

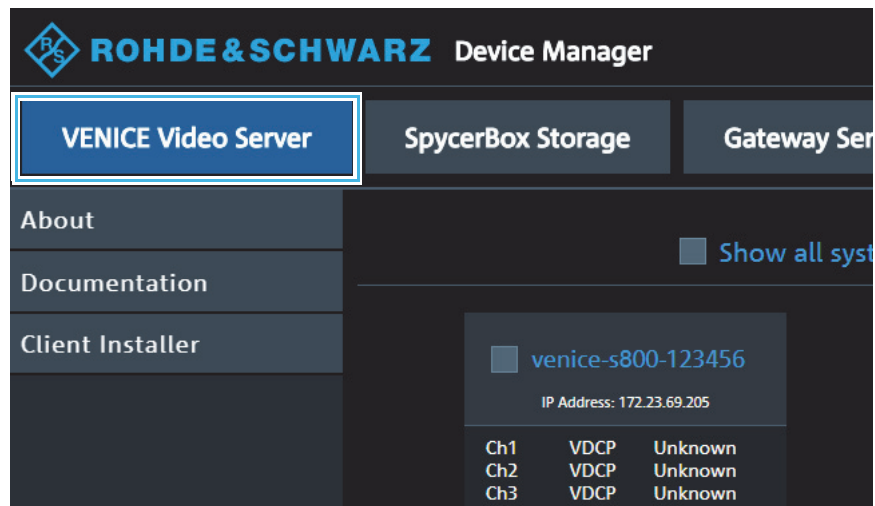

► The running mode will be indicated in the respective tile in the system view.

3. Select the respective system.

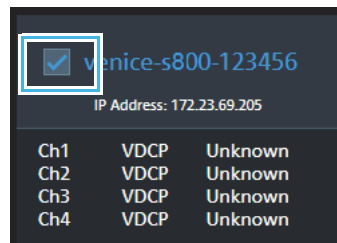

- If the system runs in another mode than VDCP select the running mode (e.g. FIMS).

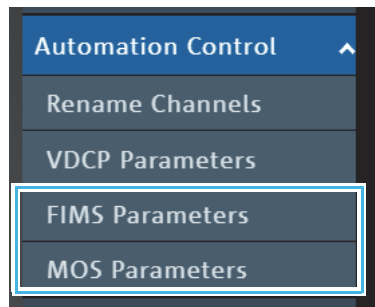

- Click **Disconnect** to make the channel available for the VDCP mode.

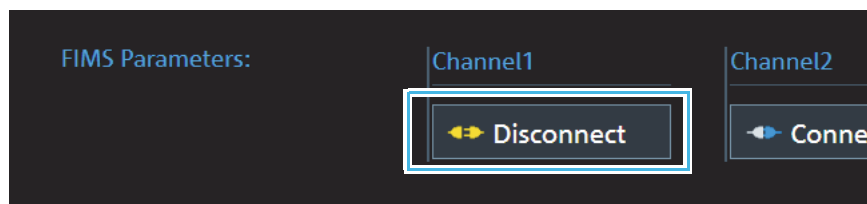

- Select the **VDCP** mode in the **Automation Control** settings.

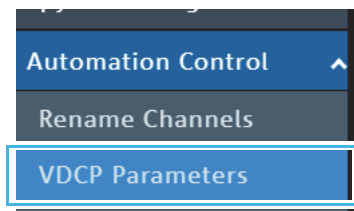

- Enter a valid **Path** to a local or a central storage for each channel.

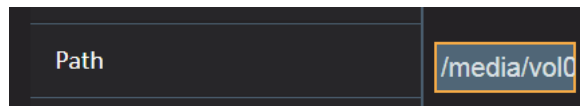

- Activate **InitiallyLocked** for each channel.

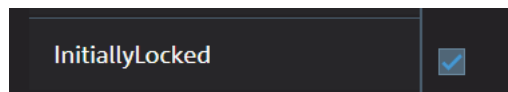

- Click **Connect** to start the VDCP mode of the respective channel.

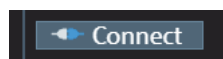

A successfully started connection of a channel in VDCP mode will be indicated in the system view.

Configuring VENICE S Services

### Video Settings

Perform the following steps:

1. Select the **Sync Reference** settings in the **Video Settings**.

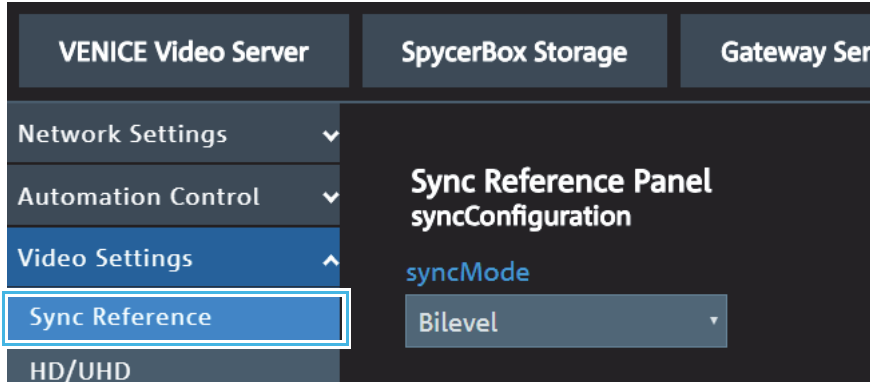

2. Set the **Sync Mode**, the **syncHPhase** and the **syncVPhase** as needed. For detailed information see the documentation of the R&S® Device Manager.

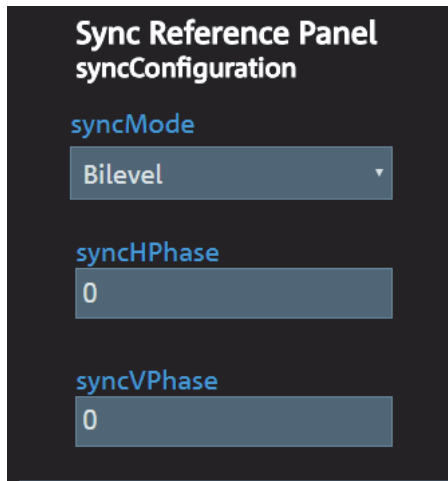

3. Select the **HD/UHD** settings in the **Video Settings**.

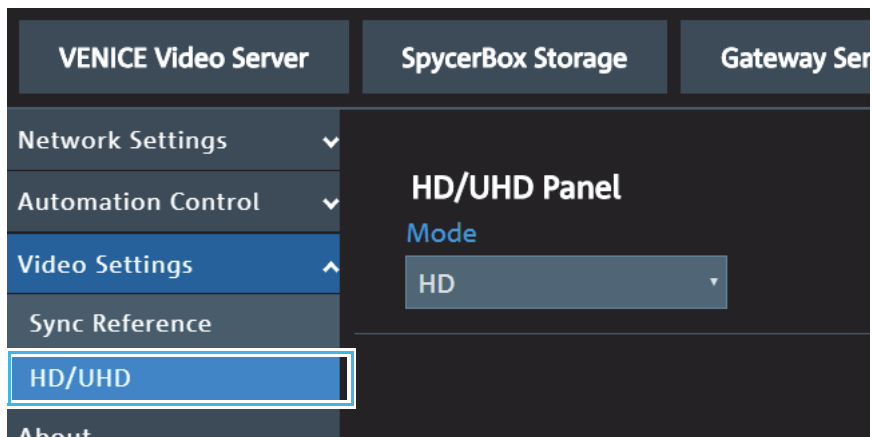

4. Set the **Mode** as needed. For detailed information see the documentation of the R&S<sup>®</sup>Device Manager.

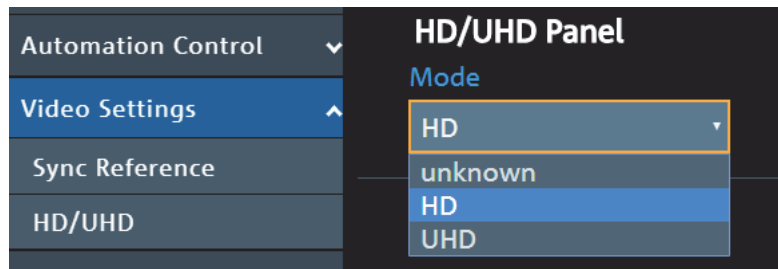

## Configuring the Subtitles

This section describes the configuration of subtitles for the VENICE S system using the R&S® Device Manager.

The following topics are covered:

- Subtitle Configuration in Device Manager (page 92)
- VDCP Subtitle Parameters (page 93)

### Subtitle Configuration in Device Manager

To access the subtitle configuration settings in Device Manager, select the associated system within the Workspace and navigate to "Video Settings" > "Record" > "Subtitle Configuration".

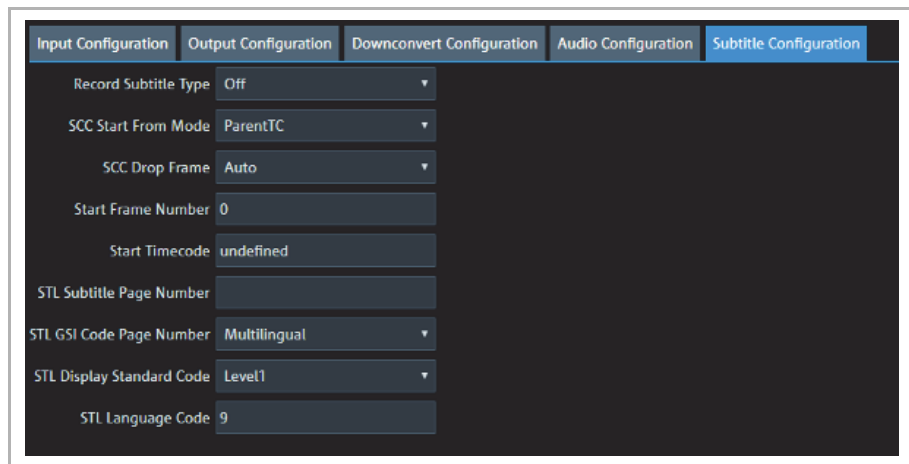

Subtitle Configuration

<b>Record Subtitle Type</b>	Determines whether subtitle recording is enabled or not (Off) and which type of subtitles (Scc1, Scc3 or Stl) should be recorded.
<b>SCC Start From Mode</b>	Specifies the start mode determination method for SCC: <ul style="list-style-type: none"> <li>• <b>StartZero</b>: Read/Write: SCC files always start at 0.</li> <li>• <b>ParentTC</b>: Read/Write: SCC files derive the starting point from the first video TC.</li> <li>• <b>Guess</b>: Read: Try to guess whether the SCC file starts with 0 or with the video TC. Write: Same as ParentTC.</li> <li>• <b>UserDefined</b>: Read/Write: The start is user-defined.</li> </ul>
<b>SCC Drop Frame</b>	Specifies the dropframe-mode determination method for SCC. <ul style="list-style-type: none"> <li>• <b>Auto</b>: SCC files dropframe-mode is determined by the video stream.</li> <li>• <b>NoneDropFrame</b>: SCC files are always non-dropframe.</li> <li>• <b>DropFrame</b>: SCC files are always dropframe.</li> </ul>
<b>Start Frame Number</b>	Determines the frame number of the first video frame calculated from the start time code for SCC and STL.



<b>Start Timecode</b>	STL: Defines the video program start timecode. Only one of startFrameNumber and startTimeCode may be present.
<b>STL Subtitle Page Number</b>	Determines the subtitle page number for STL. Enter a value in the following range: 100-899.
<b>STL GSI Code Page Number</b>	Determines a character code page for the STL GSI block (UnitedStates, Multilingual, Portugal, Canada-French, Nordic).
<b>stlDisplayStandardCode</b>	Determines the display code for STL (OpenSubtitling, Level1, Level2).
<b>stlLanguageCode</b>	Determines the language code for STL. Allowed values are: <ul style="list-style-type: none"> <li>● 04 (Croatian)</li> <li>● 06 (Czech)</li> <li>● 08 (German)</li> <li>● 09 (English)</li> <li>● 0A (Spanish)</li> <li>● 0C (Estonian)</li> <li>● 0F (French)</li> <li>● 15 (Italian)</li> <li>● 1A (Lithuanian)</li> <li>● 1B (Hungarian)</li> <li>● 20 (Polish)</li> <li>● 21 (Portuguese)</li> <li>● 22 (Romanian)</li> <li>● 24 (Serbian)</li> <li>● 25 (Slovak)</li> <li>● 26 (Slovenian)</li> <li>● 27 (Finnish)</li> <li>● 28 (Swedish)</li> <li>● 29 (Turkish)</li> </ul>

### VDCP Subtitle Parameters

In this dialog you can globally set the directory in which the VENICE S system will look for subtitle files. To access the VDCP Parameters in Device Manager, navigate to "Automation control" > "VDCP Parameters".

Configuring the Subtitles

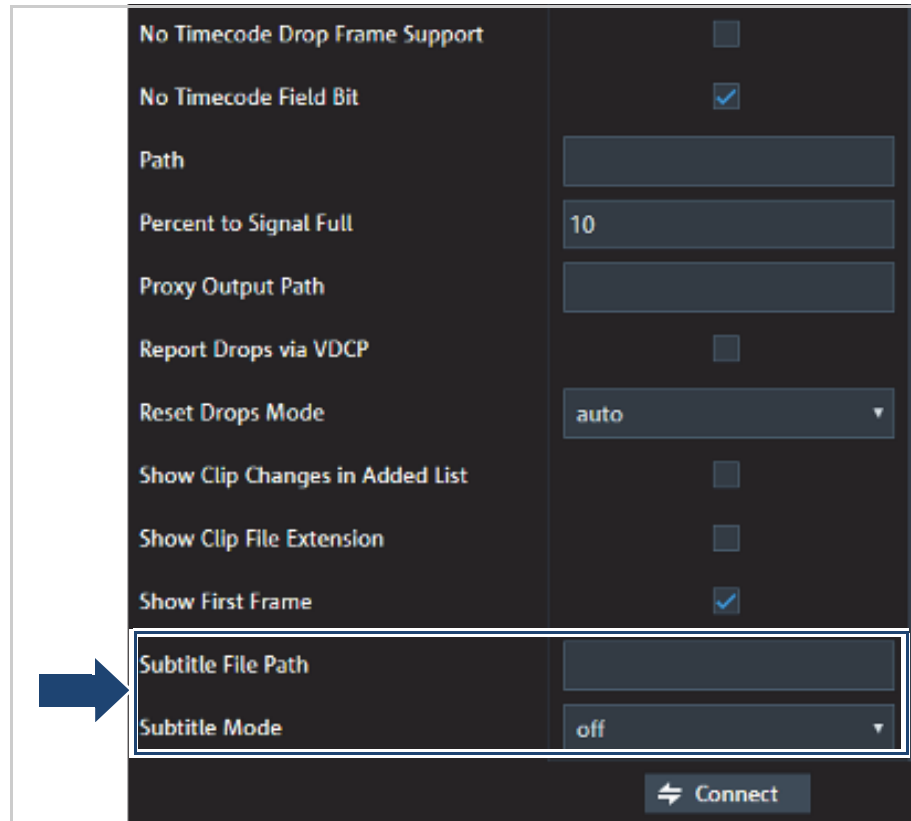

VDCP Subtitle Parameters

<b>Subtitle File Path</b>	Determines the directory where the system looks for subtitle files when 'SubtitleMode' is enabled. If this option is omitted or an empty string is given, the VDCP root directory is used.
<b>Subtitle Mode</b>	Determines whether the system automatically uses subtitle files, if available. <ul style="list-style-type: none"> <li>• <b>Off</b>: No subtitle files are used.</li> <li>• <b>Auto</b>: If a supported subtitle file for the clip is present, it will be automatically used.</li> </ul>

# Administration

This chapter is divided into the following sections:

- "User Management" (page 96)
- "Creating a Backup Image" (page 99)
- "Restoring the System" (page 102)
- "System Update" (page 105)
- "SNMP System Monitoring" (page 106)
- "Integration into an IP Network" (page 119)

## User Management

To integrate R&S VENICE S into an existing environment it is necessary to be able to change the user permissions.

To achieve this, observe the following:

- Changing the Passwords (page 96)
- Changing the User ID (page 97)
- Adding Samba Users (page 98)



The steps below are valid for R&S VENICE S with software 3.5 or higher.

### Changing the Passwords

To ensure the safety of systems connected in a network and/or to the Internet, we highly recommend to change the default password on both the R&S VENICE S server as well as the on the web UI interface of R&S@Device Manager as soon as the initial setup is completed.

#### Changing the server password

Perform the following steps:

1. Log in to the server as root user either directly or via SSH using the default/existing password. The root user is the account that has full access to all files, applications, and system functions.
2. At the prompt, type "**passwd root**" and press "Enter":

```
root@server [~]# passwd root
```

3. The system will prompt you to enter the current password. Do so, then follow the prompts to define and confirm a new root password.

```
Changing password for user root.  
New password:  
Retype new password:  
passwd: all authentication tokens updated successfully.
```

The password change takes effect immediately.

### Changing the R&S@Device Manager password

Perform the following steps:

1. Open the R&S@Device Manager on the current system.
2. Navigate to "User administration"

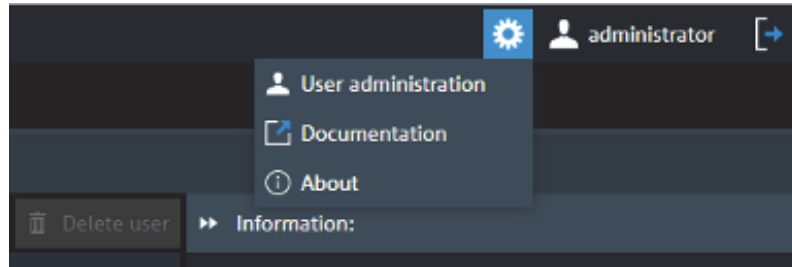

3. Select the respective user and then select "Change password".
  - ▶ The "Change password" window opens.
4. Enter the new password and confirm with "OK".

The password of the web UI is now set.

### Changing the User ID

All the R&S software on a R&S VENICE S runs as user "rsapp", who is in the group "rsapp". By default user rsapp has the user ID (UID) 1000 and the rsapp group has group ID (GID) 1000. The steps below describes how to change that.

Perform the following steps:

1. Ensure that the system is currently not used.
2. Log into the system as root, either directly or via SSH.
3. Stop all R&S processes with:  
**/opt/rohde-schwarz/fbms-services.sh stop**
4. Query the UID that is currently used by user rsapp with:  
**id -u rsapp** (By default this should be **1000**.)
5. Query the UID that is currently used by group rsapp with:  
**id -g rsapp** (By default this should be **1000**.)
6. Modify the UID (e.g. to 1234): **usermod -u 1234 rsapp**
  - ▶ If there are still processes running as rsapp, usermod will show an error message like this:  
**usermod: user rsapp is currently used by process 4224**
7. Stop the running processes if necessary.
8. Modify the GID (e.g. to 1234): **groupmod -g 1234 rsapp**

## User Management

9. Change the ownership of files that belonged to user rsapp, so they belong to that user again:  
`find / -mount -user 1000 -exec chown -h rsapp {} \;`  
→ 1000 is the UID that you query in step 4.
  - ▶ This only changes the files on the system disk (/). You can run this for your storage too, if needed.
10. Change the group affiliation of files that belonged to group rsapp, so they belong to that group again:  
`find / -mount -group 1000 -exec chgrp -h rsapp {} \;`  
→ 1000 is the GID that you query in step 4.



Due to the `-mount` option `find` will only change files on the system disk. You can run this for your storage too, if needed.

## Adding Samba Users

Perform the following steps:

1. Decide about the name and password for the new account and which group the user should be in. It might be advisable to use the rsapp group, so the user can read clips written by R&S VENICE. The default GID of the rsapp group is 1000.  
In this example we will use the name “username” and the GID “1000”.
2. Add the account:  
`useradd username -g 1000 -N -s /sbin/nologin`
3. Set a password for that user:  
`smbpasswd -a username`
  - ▶ You will be prompted for a password.

## Creating a Backup Image

The following describes the steps to make a backup image of the system disk and save it to the internal USB flash drive, see "Rescue Stick" (page 54).

Perform the following steps:

1. If appropriate, disconnect all externally connected storage devices from the system.
2. Turn on the R&S VENICE S G3. At the indicated moment during start-up you have to press **[F11]** to enter the boot menu.
  - ▶ The boot menu is displayed on the screen.
3. Select the internally installed USB flash drive as the boot device.

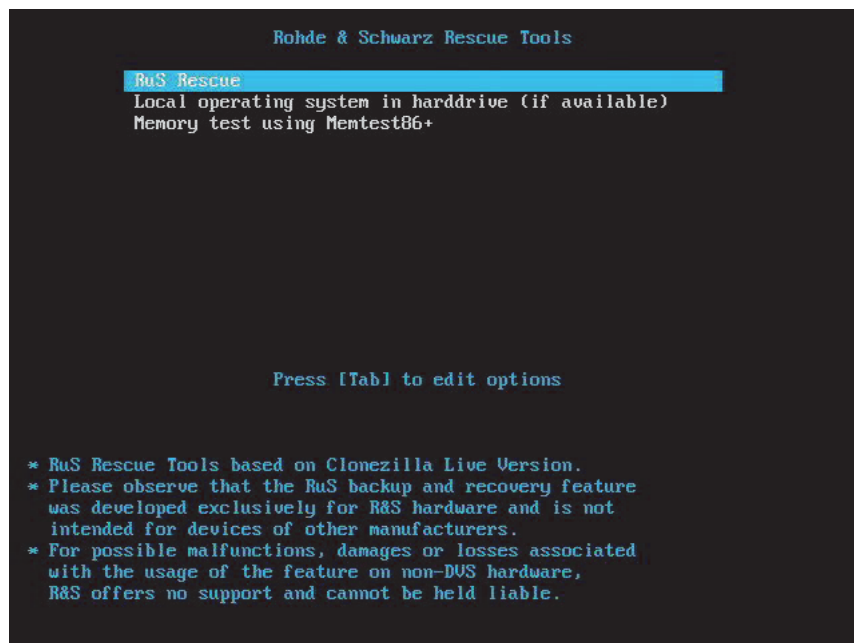

4. Press **[Enter]**.
  - ▶ The system will boot from the internal USB flash drive.
  - ▶ You will see a window on the screen where you can select the Rohde & Schwarz Rescue environment for loading.



To complete the loading of the Rohde & Schwarz Rescue environment some user entries are required. For this follow the instructions given on the screen.

The loading of the environment and the process itself will both try to initialize hardware that may not be present on your system. Any error messages displayed during loading/initialization, e.g. **Failed** or **Warning**, can be disregarded. The backup/recovery process should work nonetheless.

5. Select RuS Rescue and press **[Enter]**.



If you do not perform any action, RuS Rescue will be loaded automatically after 30 seconds.

- ▶ Once the loading has finished, you will see the RuS Rescue script with its options on the screen. Your display should look similar to the following:

```

--- RuS Rescue ---

1 - Backup on internal USB device
2 - Restore from internal USB device
3 - Backup on self selected external device
4 - Restore from self selected external device
5 - Reboot the system
6 - Poweroff the system

0 - Exit

Enter selection:

```

- To create a backup image of your system disk and save it to the internal USB flash drive, press **[1]** and then **[Enter]**.
  - ▶ A list of possible source devices will be detailed on the screen. The system disk normally is the 'ATA' disk with, for example, 'sda', 'sdb' or 'sdc' as its device name (e.g.: `1:0:0:0 disk ATA <device info> /dev/sda`).



Ex factory the R&S VENICE S G3 will be delivered with 'sda' as the default system disk. If other configurations have been made later or on customer request, this may be different.

### NOTICE

#### Data Loss

Selecting the wrong source device may lead to an unwanted configuration and malfunctions when the system is operating.

**Continue with the following steps only if you are able to identify the correct source device.**

- Enter the name of the system disk: Type in e.g. `sda` (or in other cases `sdb`, `sdc`, etc.) and press **[Enter]**.
  - ▶ The system will ask you to enter the image name for the backup image to be saved to the USB flash drive. By entering the name of an already existing backup image you can overwrite it.
- Type in the name of the image you want to save to the USB flash drive for a later recovery. To confirm your entry press **[Enter]**.
  - ▶ The system will ask you to confirm your selection and whether you want to continue:





To abort the process at this point enter **n** for 'no' and press **[Enter]**. You will be redirected to the RuS Rescue script.

After starting the process its termination is no longer possible.

9. To start the backup process type in **y** for 'yes' and press **[Enter]**.
  - ▶ The program starts the backup process. Its progress will be indicated on the screen.



The backup process may take some time.

If during the process the screen turns black, press **[Space]** to get it back again.

When the system has finished the backup process, you will be notified about this. Then after pressing **[Enter]**, you will be redirected to the Rohde & Schwarz Rescue script once more where you can choose, for example, 'reboot' or 'poweroff' to restart or turn off the system.

## Restoring the System

The following describes the steps to make a recovery of the system disk.

---

**NOTICE****Total Loss of Data**

Selecting the wrong device for restoring the system partition will lead to a total loss of data.

**Do not execute any commands if you are not sure about the correct target device.**

---

Perform the following steps:

1. If appropriate, disconnect all externally connected storage devices from the system.
2. Turn on the R&S VENICE S G3. At the indicated moment during start-up you have to press **[F11]** to enter the boot menu.
  - ▶ The boot menu is displayed on the screen.
3. Select the internally installed USB flash drive as the boot device.
4. Press **[Enter]**.
  - ▶ The system will boot from the internal USB flash drive. You will see a window on the screen where you can select the Rohde & Schwarz Rescue environment for loading.



To complete the loading of the Rohde & Schwarz Rescue environment some user entries are required. For this follow the instructions given on the screen.

The loading of the environment and the process itself will both try to initialize hardware that may not be present on your system. Any error messages displayed during loading/initialization, e.g. **Failed** or **Warning**, can be disregarded. The backup/recovery process should work nonetheless.

5. Select RuS Rescue and press **[Enter]**.



If you do not perform any action, RuS Rescue will be loaded automatically after 30 seconds.

- ▶ Once the loading has finished, you will see the Rohde & Schwarz Rescue script with its options on the screen. Your display should look similar to the following:

```

--- RuS Rescue ---

1 - Backup on internal USB device
2 - Restore from internal USB device
3 - Backup on self selected external device
4 - Restore from self selected external device
5 - Reboot the system
6 - Poweroff the system

0 - Exit

Enter selection:

```

6. To restore your system disk from the internal USB flash drive, press **[2]** and then **[Enter]**.
  - ▶ A list of possible target devices will be detailed on the screen. The system disk normally is the 'ATA' disk with, for example, 'sda', 'sdb' or 'sdc' as its device name:  
(e.g.: 1:0:0:0 disk ATA <device info> /dev/sda).



Ex factory the R&S VENICE S G3 will be delivered with 'sda' as the default system disk. If other configurations have been made later or on customer request, this may be different.

### NOTICE

#### Data Loss

A recovery will overwrite all your data.

**Continue with the following steps only when you are able to identify the correct target device.**

7. Enter the name of the system disk: Type in e.g. **sda** (or in other cases **sdb**, **sdc**, etc.) and press **[Enter]**.
  - ▶ A further list of possible source images will be detailed on the screen. If there is only the Rohde & Schwarz recovery image on the USB flash drive, this one will be listed. If there are several images, all images will be displayed.
8. Select the image you want to use for the recovery. Normally, it provides the serial number of the R&S VENICE S G3 in its name. To confirm your choice press **[Enter]**.
  - ▶ The system will ask you to confirm your selection and whether you want to continue.

## Restoring the System



To abort the process at this point enter **n** for 'no' and press **[Enter]** on your keyboard. You will be redirected to the RuS Rescue script.

After starting the process its termination is no longer possible.

9. To start the recovery process type in **y** for 'yes' and press **[Enter]**.
  - ▶ The program starts the recovery process. Its progress will be indicated on the screen.



The recovery process may take some time.

If during the process the screen turns black, press **[Space]** to get it back again.

When the system has finished the recovery process, you will be notified. Then after pressing **[Enter]**, you will be redirected to the RuS Rescue script once more where you can choose, for example, 'reboot' or 'poweroff' to restart or turn off the system. The next time the system is started, it will load the restored operating system.

## System Update

Rohde & Schwarz delivers system updates in so called RSI's. It is an executable that needs to run on a Windows computer in order to update one or more R&S systems over the network.



The entire update procedure is described in chapter "Working with the R&S Installer (RSI)" (page 145).

## SNMP System Monitoring

Using the SNMP protocol you can query the status of various components and processes. The R&S VENICE S system provides several MIB files from which you can query the status of the associated data points.

The following topics are covered:

- SNMP MIB files location (page 106)
- Understanding SNMP Naming (page 106)
- Basic System Monitoring via SNMP (page 107)
- Advanced System Monitoring via SNMP (page 109)

### SNMP MIB files location

To access the MIB files via the Device Manager navigate to "Maintenance" > "Software installer" and download the "rs-snmplib.zip" package.

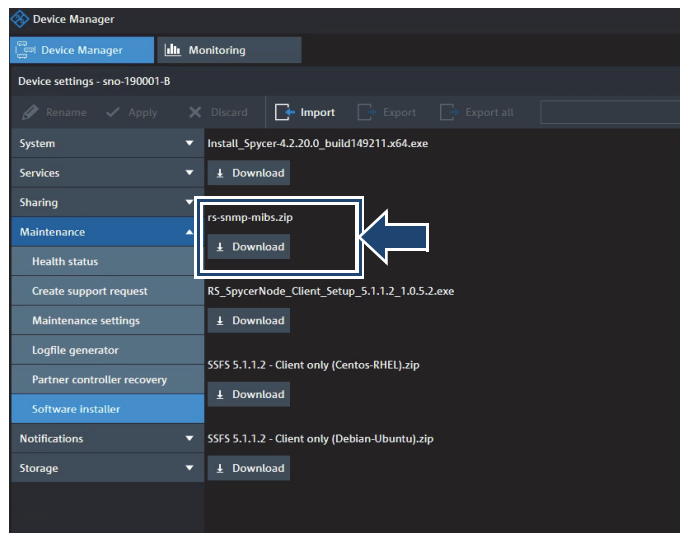

Location of the SNMP MIB files

### Understanding SNMP Naming

The SNMP naming structure contains variable parts (dimensions) which will vary depending on the type of the queried process or the location it is currently running. For example, the [Channel] and the [Stream] variables within the SNMP name

**rsSt2110V1SenderAudioCh[Channel]Id[Stream]DummyPackets**  
will indicate which channel and stream are currently being called up. This variable structure applies also to the associated object ID of the respective data point.

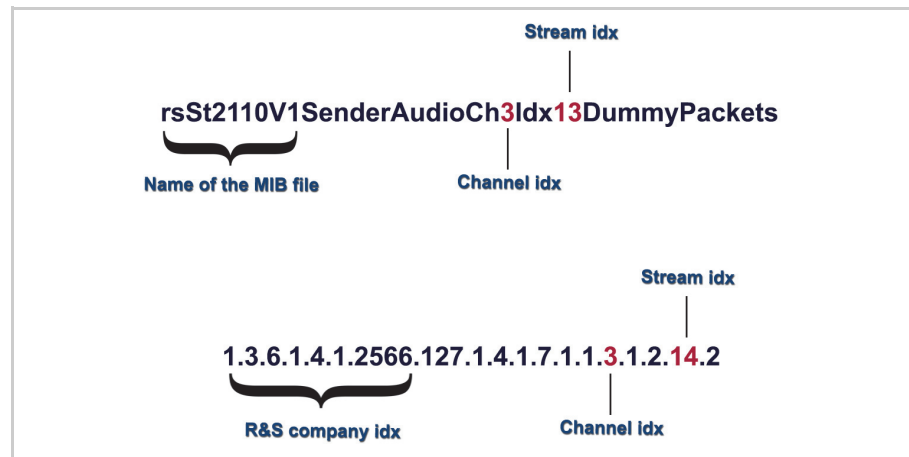

SNMP naming and OID structure

The following values are possible for each of the variables:

- Channel: 1-4, 11-14
  - **Note:** 11-14 means channel 1 to 4 on card 2. Also, index is only used when [Card] is not used
- Card: 1, 2
- Stream:
  - for video: 0
  - for ANC: 0
  - for audio: 0-15 (1-16 in the object ID)
- Storage (A/B): A or B (A and B being redundant storage systems)



To query information of non-SSFS internal R&S VENICE storages use the following SNMP data points:

- HOST-RESOURCES-MIB: data point: hrStorageTable
- UCD-SNMP-MIB: data point: dskTable

External SSFS storage information cannot be queried directly via SNMP from R&S VENICE S. If R&S VENICE S is connected to a SpycerNode system, the mounted SSFS storage information can be queried from the following SpycerNode SNMP data points:

- GPFS-MIB: gpfsFileSystemStatusTable

## Basic System Monitoring via SNMP

SNMP allows you to monitor and query the state of several basic R&S VENICE hardware components in a network such as:

- Fans
- Disks arrays
- Power supply units
- CPU

## SNMP System Monitoring

R&S VENICE S G3 provides a **StorageManagement-MIB** and **MIB-Dell-10892** that give you the opportunity to query the state of the system or parts of it, using SNMP.

**Explanation of the OIDs**

When using a monitoring software, you will have to enter all OIDs once to be able to monitor the hardware's state continuously.

File	OIDs	Object	Value
MIB-Dell-10892	.1.3.6.1.4.1.674.108 92.1.700.12.1.6.1.1	System Board Fan 1	RPM (Rounds per minute)
	.1.3.6.1.4.1.674.108 92.1.700.12.1.6.1.2	System Board Fan 2	
	.1.3.6.1.4.1.674.108 92.1.700.12.1.6.1.3	System Board Fan 3	
	.1.3.6.1.4.1.674.108 92.1.700.12.1.6.1.4	System Board Fan 4	
	.1.3.6.1.4.1.674.108 92.1.700.12.1.6.1.5	System Board Fan 5	
	.1.3.6.1.4.1.674.108 92.1.700.12.1.6.1.6	System Board Fan 6	
	.1.3.6.1.4.1.674.108 92.1.700.20.1.6.1.1	System Board Inlet Temp	Temperature in °C * 10 [the value needs to be divided by 10, e.g. reading 220 -> 22°C]
	.1.3.6.1.4.1.674.108 92.1.700.20.1.6.1.2	System Board Exhaust Temp	
	.1.3.6.1.4.1.674.108 92.1.700.20.1.6.1.3	CPU1 Temp	
	.1.3.6.1.4.1.674.108 92.1.600.12.1.5.1.1	PS1 Status	other(1), unknown(2), ok(3), nonCritical(4), critical(5), nonRecoverable(6)
.1.3.6.1.4.1.674.108 92.1.600.12.1.5.1.2	PS2 Status		
Storage Management-MIB	.1.3.6.1.4.1.674.108 93.1.20.140.1.1.4.1	System disk array (array 1)	ready(1), failed(2), online(3), offline(4), degraded(6), verifying(7), resynching(15), regenerating(16), failedRedundancy(18), rebuilding(24), formatting(26), reconstructing(32), initializing(35), backgroundInit(36), permanentlyDegraded(52)
	.1.3.6.1.4.1.674.108 93.1.20.140.1.1.4.2	Meta data disk array (array 2)	
	.1.3.6.1.4.1.674.108 93.1.20.140.1.1.4.3	Log disk array (array 3)	
	.1.3.6.1.4.1.674.108 93.1.20.140.1.1.4.4	Data disk array (array 4) <b>VENICE S407/414 only</b>	



## Advanced System Monitoring via SNMP

The following table gives a thorough overview over all the rest of the available MIB files with their data points and more information on the use cases.

Data Point	Dimension	Description	Use Case	SNMP Name
<b>rsVeniceV1MIB</b> (server channel states)				
ChannelMode	Channel, Card	The channel mode of the channel: unknown, VDCP, FIMS, MOS	Validate whether the Venice channel is in the right mode.	rsVeniceV1VideoServer[Channel]ChannelMode
OperationMode	Channel, Card	The operation mode of the channel: unknown, idle, playout, record, transform	Validate whether the Venice channel is performing the correct operation.	rsVeniceV1VideoServer[Channel]OperationMode
VideoDropFrameCount	Channel, Card	Number of video frames dropped on that channel	An increase of that value indicates that video frames have been dropped.	rsVeniceV1VideoServer[Channel]VideoDropFrameCount
AudioDropFrameCount	Channel, Card	Number of audio samples dropped on that channel	An increase of that value indicates that audio samples have been dropped.	rsVeniceV1VideoServer[Channel]AudioDropFrameCount
AncDropFrameCount	Channel, Card	Number of ANC packets dropped on that channel	An increase of that values indicates that ANC packets have been dropped.	rsVeniceV1VideoServer[Channel]AncDropFrameCount
<b>rsPriosBcV1MIB</b> (I/O board status report)				
ExternalVideoSync	Card	Status of the external video sync: unknown, connected, disconnected	Check if the video clock is synchronized to an external clock like BlackBurst or PTP	rsPriosBcV1-Card[Card]ExternalVideoSync
Name	Card	Name of the installed card: PRIOS_BC	Check which card is installed.	rsPriosBcV1-Card[Card]Name
Variant	Card	Variant of the installed card: string number e.g. "02"	Check the installed variant of the card.	rsPriosBcV1-Card[Card]Variant
SerialNumber	Card	Serial number of the card	Query the serial number of the card for maintenance reasons.	rsPriosBcV1-Card[Card]SerialNumber
SwVersion	Card	Driver version string.	Query the installed driver version for maintenance reasons.	rsPriosBcV1-Card[Card]SwVersion

## SNMP System Monitoring

Data Point	Dimension	Description	Use Case	SNMP Name
ProductionDate	Card	Date of production	For maintenance reasons if a specific charge of cards show a specific behavior.	rsPriosBcV1-Card[Card]ProductionDate
Manufacturer	Card	Rohde & Schwarz	Query manufacturer name.	rsPriosBcV1-Card[Card]Manufacturer
PCI	Card	PCI version		rsPriosBcV1-Card[Card]Pci
Temperature1	Card	Temperature on the card in milli grad Celsius: 40000		rsPriosBcV1-Card[Card]Temperature1
Temperature2	Card	Temperature on the card in milli grad Celsius: 40000		rsPriosBcV1-Card[Card]Temperature2
Temperature3	Card	Temperature on the card in milli grad Celsius: 40000		rsPriosBcV1-Card[Card]Temperature3
FanSpeed	Card	Speed of the fan. Value only provided if the card has a fan.		rsPriosBcV1-Card[Card]FanSpeed
TemperatureError	Card	Enumeration that signals an temperature error: ok, fault	Check if temperature limit has been reached.	rsPriosBcV1-Card[Card]TemperatureError
FanError	Card	Enumeration that signals an fan error: ok, fault	Same as temperatureError	rsPriosBcV1-Card[Card]FanError
PowerError	Card	Enumeration that signals an power error: ok, fault	Same as temperatureError	rsPriosBcV1-Card[Card]PowerError
VideoInput	Channel, Card	Video input status: unknown, detected, notDetected	Check if there is a valid video input signal connected to this channel.	rsPriosBcV1-Card[Card]Channel[Channel]VideoInput
ExternalVideo-SyncStatus	Channel, Card	Status of the external video sync: unknown, unlocked, locked	If external video sync is used, check if the video channel is locked to the external video clock.	rsPriosBcV1-Card[Card]Channel[Channel]ExternalVideo-SyncStatus
EmbeddedAudio1	Channel, Card	Status of the first four embedded audio channels: unknown, detected, notDetected	Check if all embedded audio channels are connected, e.g. received over SDI.	rsPriosBcV1-Card[Card]Channel[Channel]EmbeddedAudio1

Data Point	Dimension	Description	Use Case	SNMP Name
EmbeddedAudio2	Channel, Card		Check if all embedded audio channels are connected, e.g. received over SDI.	rsPriosBcV1-Card[Card]Channel[CChannel]EmbeddedAudio2
EmbeddedAudio3	Channel, Card		Check if all embedded audio channels are connected, e.g. received over SDI.	rsPriosBcV1-Card[Card]Channel[CChannel]EmbeddedAudio3
EmbeddedAudio4	Channel, Card		Check if all embedded audio channels are connected, e.g. received over SDI.	rsPriosBcV1-Card[Card]Channel[CChannel]EmbeddedAudio4
AesAudio1	Channel, Card	Status of the first two AES audio channels: unknown, detected, notDetected	Check if all AES audio channels are connected, e.g. received over SDI.	rsPriosBcV1-Card[Card]Channel[CChannel]EmbeddedAudio1
AesAudio2	Channel, Card	Status of the second two AES audio channels: unknown, detected, notDetected	Check if all AES audio channels are connected, e.g. received over SDI.	rsPriosBcV1-Card[Card]Channel[CChannel]EmbeddedAudio2
AesAudio3	Channel, Card	Status of the second two AES audio channels: unknown, detected, notDetected	Check if all AES audio channels are connected, e.g. received over SDI.	rsPriosBcV1-Card[Card]Channel[CChannel]EmbeddedAudio3
AesAudio4	Channel, Card	Status of the second two AES audio channels: unknown, detected, notDetected	Check if all AES audio channels are connected, e.g. received over SDI.	rsPriosBcV1-Card[Card]Channel[CChannel]EmbeddedAudio4
<b>rsSt2110V1MIB</b> (ST2110 video over IP specific information)				
VideoSenderActive	Stream, Channel, (Card included in Channel idx)	Status of the sender: active, inactive	This is always active as the data point is not available if the IP daemon is not running.	rsSt2110V1Sender-VideoCh[Channel]Id[Stream]Active
VideoSenderRtp-PktCnt	Stream, Channel, (Card included in Channel idx)	Number of RTP Packets send	An increasing count signals that packets have been sent.	rsSt2110V1Sender-VideoCh[Channel]Id[Stream]RtpPktCnt
AudioSenderActive	Stream, Channel, (Card included in Channel idx)	Status of the sender: active, inactive	This is always active as the data point is not available if the IP daemon is not running	rsSt2110V1Sender-AudioCh[Channel]Id[Stream]Active

## SNMP System Monitoring

Data Point	Dimension	Description	Use Case	SNMP Name
AudioSenderDummyPackets	Stream, Channel, (Card included in Channel idx)	Number of dummy packets sent.		rsSt2110V1Sender-AudioCh[Channel]Id[Stream]DummyPackets
AudioSenderFutureDroppedPackets	Stream, Channel, (Card included in Channel idx)	Number of packets dropped because they are scheduled in the future.	Number of packets provided too early to the driver.	rsSt2110V1Sender-AudioCh[Channel]Id[Stream]FutureDroppedPackets
AudioSenderPastDroppedPackets	Stream, Channel, (Card included in Channel idx)	Number of packets dropped because they are in the past.	Number of packets provided too late to the driver.	rsSt2110V1Sender-AudioCh[Channel]Id[Stream]PastDroppedPackets
AudioSenderAllPackets	Stream, Channel, (Card included in Channel idx)	Number of total packets sent.	If this number increases something has been sent.	rsSt2110V1Sender-AncCh[Channel]Id[Stream]DummyPackets
AncSenderActive	Stream, Channel, (Card included in Channel idx)	Status of the sender: active, inactive	This is always active as the data point is not available if the IP daemon is not running.	rsSt2110V1Sender-AncCh[Channel]Id[Stream]Active
AncSenderDummyPackets	Stream, Channel, (Card included in Channel idx)	Number of dummy packets sent.	Number of packets without any content in a drop case.	rsSt2110V1Sender-AncCh[Channel]Id[Stream]DummyPackets
AncSenderFutureDroppedPackets	Stream, Channel, (Card included in Channel idx)	Number of packets dropped because they are in the future	Number of packets provided too early to the driver.	rsSt2110V1Sender-AncCh[Channel]Id[Stream]FutureDroppedPackets
AncSenderPastDroppedPackets	Stream, Channel, (Card included in Channel idx)	Number of packets dropped because they are in the past.	Number of packets provided too late to the driver.	rsSt2110V1Sender-AncCh[Channel]Id[Stream]PastDroppedPackets
AncSenderAllPackets	Stream, Channel, (Card included in Channel idx)	Number of total packets sent.	If this number increments something has been sent.	rsSt2110V1Sender-AncCh[Channel]Id[Stream]AllPackets
VideoReceiverActive	Stream, Channel, (Card included in Channel idx)	Status of the receiver: active, inactive	This is always active as the data point is not available if the IP daemon is not running.	rsSt2110V1Receiver-VideoCh[Channel]Idx[Stream]Active
VideoReceiverRtpPktValid	Stream, Channel, (Card included in Channel idx)	Number of valid packets received.	An incrementing count signals that packets have been received.	rsSt2110V1Receiver-VideoCh[Channel]Idx[Stream]RtpPktValid
VideoReceiverRtpPktUnrecv	Stream, Channel, (Card included in Channel idx)	Unrecoverable packet count increments when a media packet is missing in the channel stream.	An incrementing count signals that packets are missing - > frame/line/pixel drop.	rsSt2110V1Receiver-VideoCh[Channel]Idx[Stream]RtpPktUnrecv

Data Point	Dimension	Description	Use Case	SNMP Name
VideoReceiverRtpPktCorr	Stream, Channel, (Card included in Channel idx)	Corrected packet count increments when a media packet is being recovered in the channel stream.	An increasing count signals that packets could be recovered from received data (leg1 or leg2).	rsSt2110V1Receiver-VideoCh[Channel]Idx[Stream]RtpPktCorr
VideoReceiverRtpPktDup	Stream, Channel, (Card included in Channel idx)	Duplicated packet count increments when a channel received a media packet that already exists in the media buffer. The count also increases for redundant St2022-7 packets.	An increasing count signals that packages have been received twice. This could indicate that there are multiple streams in the network using the same transport parameters. When St2022-7 is enabled, the packets received on leg 2 are counted as duplicate packets. For St2022-7 this count can be used to validate the quality of the secondary stream. As long as this counter and the VideoReceiverRtpPktValid counter increase with the same packet rate, all packets of the secondary stream have been received.	rsSt2110V1Receiver-VideoCh[Channel]Idx[Stream]RtpPktDup
VideoReceiverRtpPktCnt	Stream, Channel, (Card included in Channel idx)	Total number of RTP Packets received by the interface.	An incrementing count signals that packets have been received. However, it does not tell anything about the quality of the packets.	rsSt2110V1Receiver-VideoCh[Channel]Idx[Stream]RtpPktCnt
AudioReceiverActive	Stream, Channel, (Card included in Channel idx)	Status of the receiver: active, inactive	This is always active as the data point is not available if the IP daemon is not running.	rsSt2110V1Receiver-AudioCh[Channel]Idx[Stream]Active
AudioReceiverOutOfOrderPackets	Stream, Channel, (Card included in Channel idx)	The counter increases if the packet queue needs to be reordered because of missing sequence numbers.	Signals gaps in received sequence numbers. Might indicate missing packets or a switch to another sender or stream.	rsSt2110V1Receiver-AudioCh[Channel]Idx[Stream]OutOfOrderPackets

## SNMP System Monitoring

Data Point	Dimension	Description	Use Case	SNMP Name
AudioReceiver-DroppedPackets	Stream, Channel, (Card included in Channel idx)	Number of dropped packets due to full queue.	An increasing value indicates that incoming packets could not be processed in time. Thus the queue is full and packages need to be dropped.	rsSt2110V1Receiver-AudioCh[Channel]Idx[Stream]Dropped-Packets
AudioReceiverDuplicates	Stream, Channel, (Card included in Channel idx)	Number of duplicate packets.	An increasing count signals that packages have been received twice. This could indicate that there are multiple streams in the network using the same transport parameters. When St2022-7 is enabled, the packets received on leg 2 are counted as duplicate packets. For St2022-7 this count can be used to validate the quality of the secondary stream. As long as this counter and the VideoReceiverRtpPkt-Valid counter increase with the same packet rate, all packets of the secondary stream have been received.	rsSt2110V1Receiver-AudioCh[Channel]Idx[Stream]Duplicates
AudioReceiver-ValidPackets	Stream, Channel, (Card included in Channel idx)	Number of valid packets received.	An increasing count signals that correct packets have been received. The received data could still have errors due to missing or corrupted packets.	rsSt2110V1Receiver-AudioCh[Channel]Idx[Stream]ValidPackets
AudioReceiver-MissingPackets	Stream, Channel, (Card included in Channel idx)	Number of missing packets.	An increasing count signals that packets are missing -> samples drop	rsSt2110V1Receiver-AudioCh[Channel]Idx[Stream]Missing-Packets

Data Point	Dimension	Description	Use Case	SNMP Name
AudioReceiverReceivedPacketsOnLeg1	Stream, Channel, (Card included in Channel idx)	Number of pakets received by the interface for leg 1 (primary St2022-7 stream)	An increasing count signals that packets from the primary stream have been received. For St2022-7 this count should increase with the same rate as ReceivedPacketsOnLeg2.	rsSt2110V1Receiver-AudioCh[Channel]Idx[Stream]Received-PacketsOnLeg1
AudioReceiverReceivedPacketsOnLeg2	Stream, Channel, (Card included in Channel idx)	Number of pakets received by the interface for leg 2 (secondary St2022-7 stream)	An increasing count signals that packets from the primary stream have been received. For St2022-7 this count should increase with the same rate as ReceivedPacketsOnLeg1.	rsSt2110V1Receiver-AudioCh[Channel]Idx[Stream]Received-PacketsOnLeg2
AncReceiverActive	Stream, Channel, (Card included in Channel idx)	Status of the receiver: active, inactive	This is always active as the data point is not available if the IP daemon is not running.	rsSt2110V1Receiver-AncCh[Channel]Idx[Stream]Active
AncReceiverOutOfOrderPackets	Stream, Channel, (Card included in Channel idx)	The counter increases if the packet queue needs to be reordered because of missing sequence numbers.	Signals gaps in received sequence numbers. Might indicate missing packets or a switch to another sender or stream.	rsSt2110V1Receiver-AncCh[Channel]Idx[Stream]OutOfOrder-Packets
AncReceiverDroppedPackets	Stream, Channel, (Card included in Channel idx)	Number of dropped packets due to full queue.	An increasing value indicates that incoming packets could not be processed in time. Thus the queue is full and packages need to be dropped.	rsSt2110V1Receiver-AncCh[Channel]Idx[Stream]Dropped-Packets

## SNMP System Monitoring

Data Point	Dimension	Description	Use Case	SNMP Name
AncReceiverDuplica- tes	Stream, Channel, (Card included in Channel idx)	Number of duplicate packets.	An increasing count signals that pack- ages have been received twice. This could indicate that there are multiple streams in the network using the same transport parameters. When St2022-7 is enabled, the packets received on leg 2 are counted as duplicate packets. For St2022-7 this count can be used to validate the quality of the secondary stream. As long as this counter and the VideoReceiverRtpPkt- Valid counter increase with the same packet rate, all packets of the secondary stream have been received.	rsSt2110V1Receiver- AncCh[Channel]Idx[St ream]Duplicates
AncReceiverValid- Packets	Stream, Channel, (Card included in Channel idx)	Number of valid packets received.	An increasing count signals that correct packets have been received. The received data could still have errors due to missing or corrupted packets.	rsSt2110V1Receiver- AncCh[Channel]Idx[St ream]ValidPackets
AncReceiverMiss- ingPackets	Stream, Channel, (Card included in Channel idx)	Number of missing packets.	An increasing count signals that packets are missing -> drop	rsSt2110V1Receiver- AncCh[Channel]Idx[St ream]MissingPackets
AncReceiverRe- ceivedPacketsOn- Leg1	Stream, Channel, (Card included in Channel idx)	Number of pakets received by the inter- face for leg 1 (primary St2022-7 stream)	An increasing count signals that packets from the primary stream have been received. For St2022- 7 this count should increase with the same rate as ReceivedPacketsOn- Leg2.	rsSt2110V1Receiver- AncCh[Channel]Idx[St ream]ReceivedPack- etsOnLeg1



Data Point	Dimension	Description	Use Case	SNMP Name
AncReceiverReceivedPacketsOnLeg2	Stream, Channel, (Card included in Channel idx)	Number of pakets received by the inter-face for leg 2 (secondary St2022-7 stream)	An increasing count signals that packets from the primary stream have been received. For St2022-7 this count should increase with the same rate as ReceivedPacketsOnLeg1.	rsSt2110V1Receiver-AncCh[Channel]Idx[Stream]ReceivedPacketsOnLeg2
<b>rsVsaV1MIB</b> (virtual storage layer)				
Name	Storage (A/B)	Path of the storage	Query the storage path.	rsVsaS-torage[A/B]Name
UUID	Storage (A/B)	UUID of the storage	Query the storage uuid.	rsVsaS-torage[A/B]Uuid
State	Storage (A/B)	State of the storage: Unknown, Ok, Offline, WriteOnly, QueueFull	Query the storage state.	rsVsaS-torage[A/B]State
<b>rsSyncdV1MIB</b> (internal storage information)				
DaemonState	1	State of the daemon: Undef, Unkonwn, Inprogress, Primary, Secondary	Query the state of the daemon.	rsSyncdV1Daemon-State
SyncState	1	Synchronization status of the daemon: Undef, Idle, Running, Failed	Query the synchroni-zation state.	rsSyncdV1SyncState
SyncElements	1	Number of elements		rsSyncdV1SyncEle-ments
Name	Storage (A/B)	Path of the storage	Query the storage path.	rsSyncd-VStorage[A/B]Name
UUID	Storage (A/B)	UUID of the storage	Query the storage uuid.	rsSyncd-VStorage[A/B]Uuid
State	Storage (A/B)	State of the storage: Undefined, Online, Offline, Inconsistent	Query the storage state	rsSyncd-VStorage[A/B]State
<b>HOST-RESOURCES-MIB</b> (third-party standard library)				
hrStorageTable	Table	Monitoring of storage level for local mount points (no SSFS support) (3rd-party-mib)		hrStorageTable

## SNMP System Monitoring

Data Point	Dimension	Description	Use Case	SNMP Name
<b>UCD-SNMP-MIB</b> (third-party standard library)				
dskTable	Table	Monitoring of storage level for local mount points (no SSFS support) (3rd-party-mib)	The table entries must be added to /etc/snmp/snmpd.conf , e.g. disk /media/vol0 for monitoring the mount point. Traps can also be configured that fire if a storage limit has been reached.	dskTable

## Integration into an IP Network

This section guides you through the process of transforming R&S VENICE S with SDI support to also support professional video, audio and ancillary data transmission over an IP network.

The following topics are covered

- Preconditions (page 119)
- General Network Settings (page 120)
- Installing the IP Software (page 123)
- Channel Configuration (page 123)
- Activating the SMPTE 2110 IP Interfaces (page 124)
- Configuring the PTP Sync Mode (page 125)
- Configuring the PTP Parameters (page 127)
- Configuring the NMOS Node Settings (page 128)
- NMOS Stream Configuration (page 128)

### Preconditions

For the integration into an IP network, R&S VENICE S G3 requires the installation of SFP modules which have to be ordered separately.

#### Ordering Information

Article name	Article order number	Comments
VEN-B433 VOIP SFP BUNDLE (4X)	2906.1574.02	R&S VENICE S4: 1x needed R&S VENICE S8: 2x needed

R&S VENICE S G3 might be connected with up to three different networks:

- Management network for configuration and video server protocols (VDCP, FIMS, MOS, VeniceWS, WSDD)
- Media over IP network (SMPTE 2110, NMOS)
- **Optional:** Storage network (e.g. SpycerNode)



We recommend to use static IP addresses on all required R&S VENICE S network interfaces (no DHCP).

## Integration into an IP Network

## Required Interfaces

Interface	Card [cardIndex]	SMPTE 2110 Port [portIndex]	Model
rsip0s0 (Default 2022-7 main interface)	0	0	R&S VENICE S4/S8
rsip0s1 (Default 2022-7 secondary interface)		1	
rsip0s2		2	
rsip0s3		3	
rsip1s0 (Default 2022-7 main interface)	1	0	R&S VENICE S8 only
rsip1s1 (Default 2022-7 secondary interface)		1	
rsip1s2		2	
rsip1s3		3	

## General Network Settings

For the initial configuration of the IP settings, a client PC is required that is directly connected to the default 1G configuration network interface "eno8403" on the R&S VENICE S G3 server (factory default: static IP 10.0.0.8). The corresponding client PC's network port needs to be configured to an IP address that is in the same network (e.g. 10.0.0.9).

## Configuring the IP interfaces

If the R&S VENICE S server already got a dedicated management network IP configured on one of the two available 1G network interfaces ("eno8303" or "eno8403"), just use that port for the network settings configuration.

Perform the following steps:

1. Open the R&S@Device Manager in your Chrome browser by using the management network interface IP address.
2. Log in to the Device Manager web frontend:  
username: **administrator**; password: **[serial number of the device]**  
With version 1.0.0.0 to 1.5.1.0 use password **admin**.

3. Click the **R&S VENICE MEDIA SERVER** tab in the "Device Manager" section and select the corresponding R&S VENICE server.

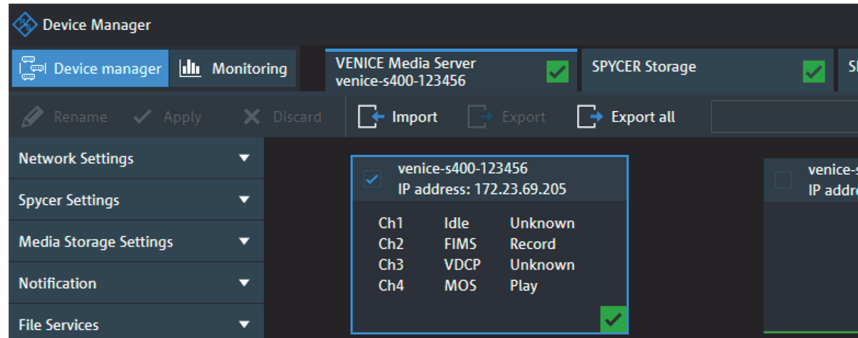

4. Navigate to **System > Network interface settings**.

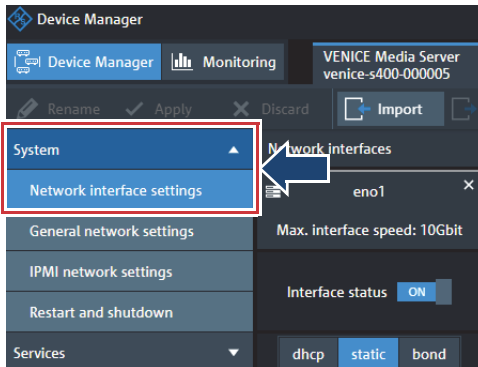

5. Configure all IP interfaces for all used networks.

IP interfaces

Port	Network Interface	Comments
<b>eno1</b>	Storage	optional
<b>eno3</b>	Management	required
<b>rsip[cardIndex]s[portIndex]</b> See also Required Interfaces in "Preconditions" (page 119)	Media over IP	required

## Integration into an IP Network

**Default Gateway and DNS Server**

Perform the following steps:

1. Select **General Network Settings** in the **System** settings.
2. Configure the default gateway and DNS server (Name Server 1 - 3) addresses as needed.

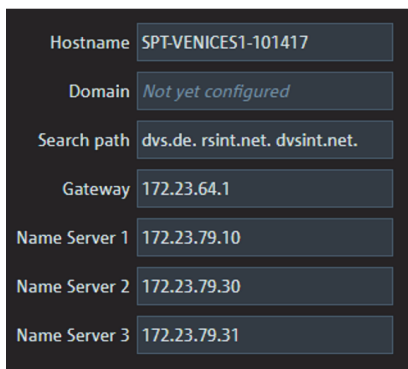

A screenshot of a configuration interface showing network settings. The fields are as follows:

Hostname	SPT-VENICES1-101417
Domain	Not yet configured
Search path	dvs.de. rsint.net. dvsint.net.
Gateway	172.23.64.1
Name Server 1	172.23.79.10
Name Server 2	172.23.79.30
Name Server 3	172.23.79.31

**IPMI Settings**

We recommend a static network configuration.

Perform the following steps:

- Configure the IPMI management interface network settings.

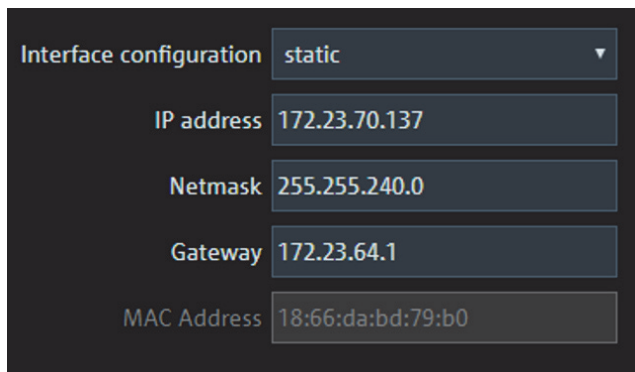

A screenshot of an IPMI interface configuration interface. The fields are as follows:

Interface configuration	static
IP address	172.23.70.137
Netmask	255.255.240.0
Gateway	172.23.64.1
MAC Address	18:66:da:bd:79:b0

## Installing the IP Software

Perform the following steps:

1. Download the latest RSI release package from GLORIS  
<https://gloris.rohde-schwarz.com>
2. Start the RSI executable on your Windows client PC that is connected to the same management network the R&S VENICE S G3 is connected to.
3. Click through the installation menu until you can select servers.
4. Select all R&S VENICE S G3 servers you want to update and start the installation.



If the firmware of the server's video I/O card was changed, the server will be automatically cold rebooted.

## Channel Configuration

Perform the following steps:

1. Open the R&S@Device Manager as described in "Configuring the IP interfaces" (page 120) and select the corresponding video server.
2. Navigate to **Video settings > HD/UHD**.
3. Select **SMPTE2110HD** or **SMPTE2110UHD** as mode for all available cards.

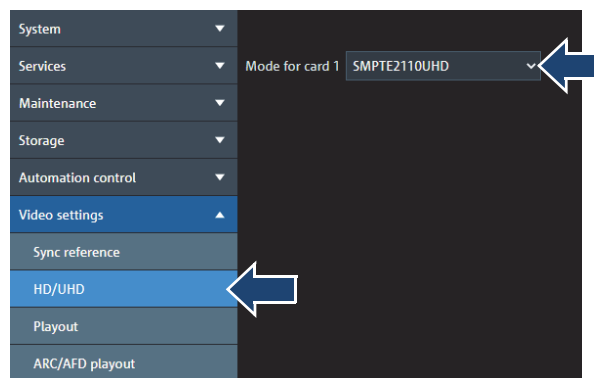

4. Press Apply to confirm your settings.



This triggers a restart of the R&S VENICE S server.

## Activating the SMPTE 2110 IP Interfaces

Perform the following steps:

1. Open the R&S@Device Manager as described in "Configuring the IP interfaces" (page 120) and select the corresponding video server.
2. Navigate to **System > Network interface settings**.
3. Switch **INTERFACE STATUS** to **ON** for all required interfaces, see also "Preconditions" (page 119) for the required interfaces.

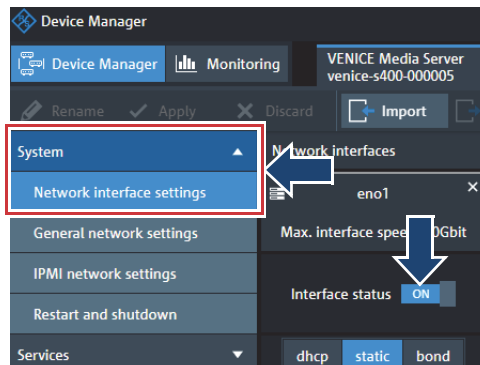

4. Configure static or DHCP settings.
5. Press **Apply** to confirm your settings.
6. Each time you change the network settings the network service is restarted on the associated device. Press OK to confirm the warning message.

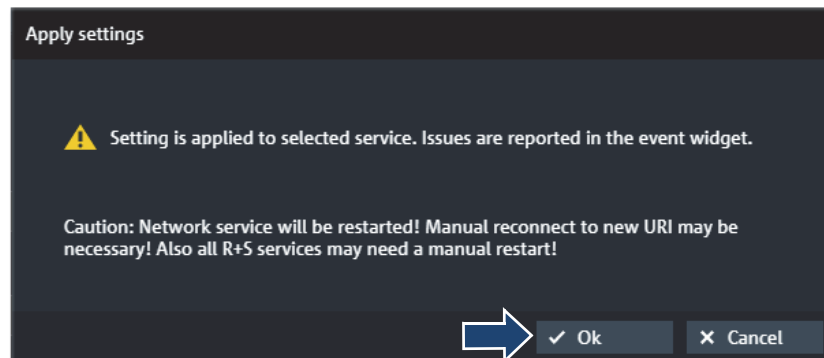



## Configuring the PTP Sync Mode

The PTP sync mode can be configured either through the R&S®Device Manager or via the R&S VENICE Web Service (VeniceWS)

### Using the R&S®Device Manager

Perform the following steps:

1. Open the R&S®Device Manager as described in "Configuring the IP interfaces" (page 120) and select the corresponding video server.
2. Navigate to **Video Settings> Sync Reference**.



The **Sync Reference** panel will be displayed only if all channels of the selected R&S VENICE S are set to **IDLE UNKNOWN** state, which requires them to be disconnected from current service. If the panel is displayed in your case, proceed directly with step 4, otherwise first perform step 3.

3. **(Optional)** To disconnect the channels, do the following:
  - Navigate to **Automation control** and check which service is started on each channel. You may have to click through each of the parameters sections (VDCP, FIMS or MOS) to locate the channel and the running service.
  - For each running channel click the **Disconnect** button.

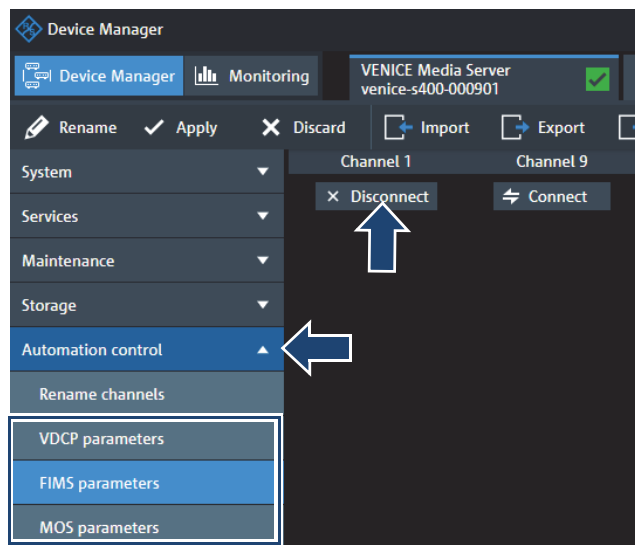

4. In the Sync Reference panel set **CURRENT CHANNEL** to **1**.

## Integration into an IP Network

5. Select **SYNC CONFIGURATION** and set **SYNC MODE** to **PTP**.

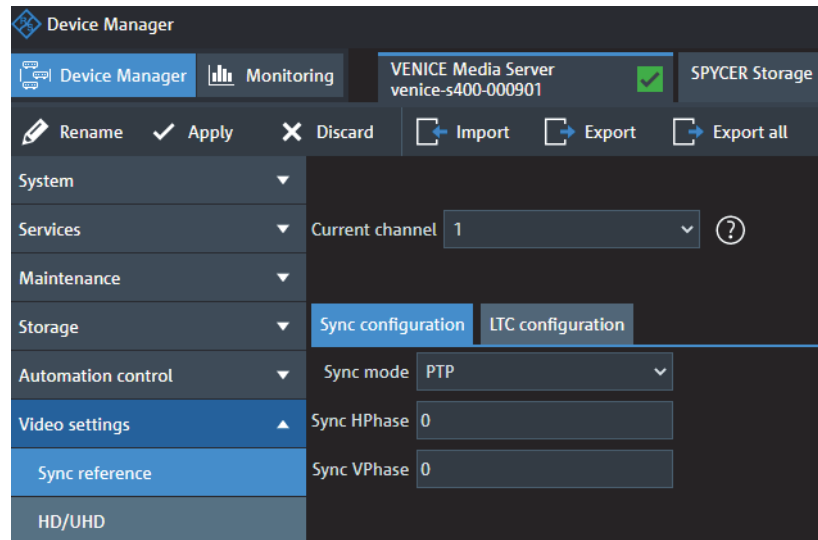

6. Repeat steps 4 and 5 with **CURRENT CHANNEL** being set to **11**.
7. Press **Apply** to confirm your settings.

### Using the R&S VENICE Web Service (VeniceWS)

Perform the following steps:

1. Use the VeniceWS SOAP request **querySyncConfigurationRequest** to check if R&S VENICE S G3 uses PTP synchronization mode. Send the following command to **[Management-IP]:8011** and **[Management-IP]:8021**:

```
<soapenv:Envelope
xmlns:soapenv="http://schemas.xmlsoap.org/soap/envelope/"
xmlns:urn="urn:rus:webservices:venice">
  <soapenv:Header/>
  <soapenv:Body>
    <urn:querySyncConfigurationRequest/>
  </soapenv:Body>
</soapenv:Envelope>
```

- Set R&S VENICE S to PTP clock synchronization mode with the VeniceWS SOAP request `configureSyncRequest`. Send the following request to `[Management-IP]:8011` and `[Management-IP]:8021`:

```
<soapenv:Envelope
xmlns:soapenv="http://schemas.xmlsoap.org/soap/envelope/"
xmlns:urn="urn:rus:webservices:venice">
<soapenv:Header/>
<soapenv:Body>
<urn:configureSyncRequest>
<urn:syncConfiguration>
<!--Optional:-->
<urn:syncMode>PTP</urn:syncMode>
<urn:syncHPhase>0</urn:syncHPhase>
<urn:syncVPhase>0</urn:syncVPhase>
</urn:syncConfiguration>
<!--Optional:-->
</urn:configureSyncRequest>
</soapenv:Body>
</soapenv:Envelope>
```

## Configuring the PTP Parameters



Both interfaces `rsipXs1` and `rsipXs0` of the corresponding card X need to be enabled even if only one interface is connected to the network. Otherwise PTP will not work correctly after reboot. See also "Activating the SMPTE 2110 IP Interfaces" (page 124) for activation instructions.

Perform the following steps:

- Open the R&S@Device Manager as described in "Configuring the IP interfaces" (page 120) and select the corresponding video server.
- Navigate to **Services > PTP settings**.
- Determine the defaults for your specific PTP environment.

System	PTP domain number	127
Services	Network mode	Hybrid (Multicast: Sync, Folk)
R&S services panel	Announce interval	-2
Spycer settings	Announce timeout count	3
SpycerNet settings	Delay-Request rate offset	0
NTP settings	Delay measurement mechanism	End to End (Sync+DelayReq)
Samba settings	Peer delay request interval	0
NFS settings	Apply defaults to the above settings	<input type="checkbox"/>
PTP settings		
Mail server		

- Press **Apply** to confirm your settings.



This panel also contains PTP status monitoring information for one card of R&S VENICE S4 and two cards of R&S VENICE S8.

## Configuring the NMOS Node Settings

Configuration of NMOS node settings is available via the R&S®Device Manager.

Perform the following steps:

1. Open the R&S®Device Manager as described in "Configuring the IP interfaces" (page 120) and select the corresponding video server.
2. Navigate to **Video settings > Global NMOS settings**.
3. Set the corresponding values for R&S VENICE S G3:

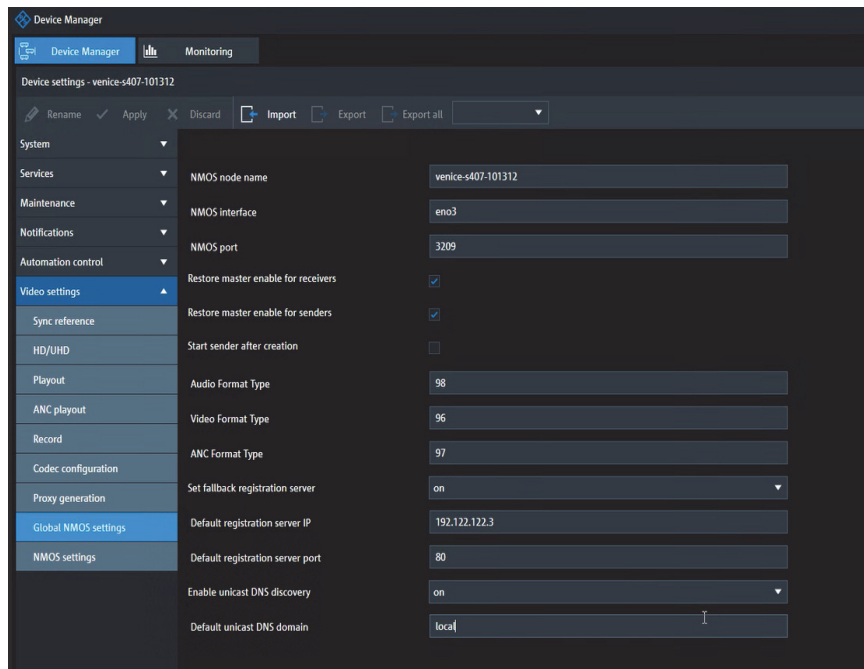

The last four settings at the bottom are intended for unicast based registration servers. There is no need to specify those settings if a multicast based registration server is used.

## NMOS Stream Configuration

Instead of one SDI input port and one SDI output port for video, audio and ANC I/O, the IP R&S VENICE provides NMOS resources for sending and receiving IP streams over one channel. In contrast to SDI, specific NMOS sender and receiver resources need to be configured separately for each data type, such as audio, video and ANC. These resources are prepared externally as JSON files which are then imported using the Device Manager interface.

There can also be multiple instances of NMOS resources of the same data type. R&S VENICE S G3 currently supports one video sender and receiver, one ANC sender and receiver and up to 16 audio senders and receivers per channel.

**NMOS Settings** Perform the following steps:

1. In the Device Manager select the requested R&S VENICE server and navigate to **Video settings > NMOS settings**.

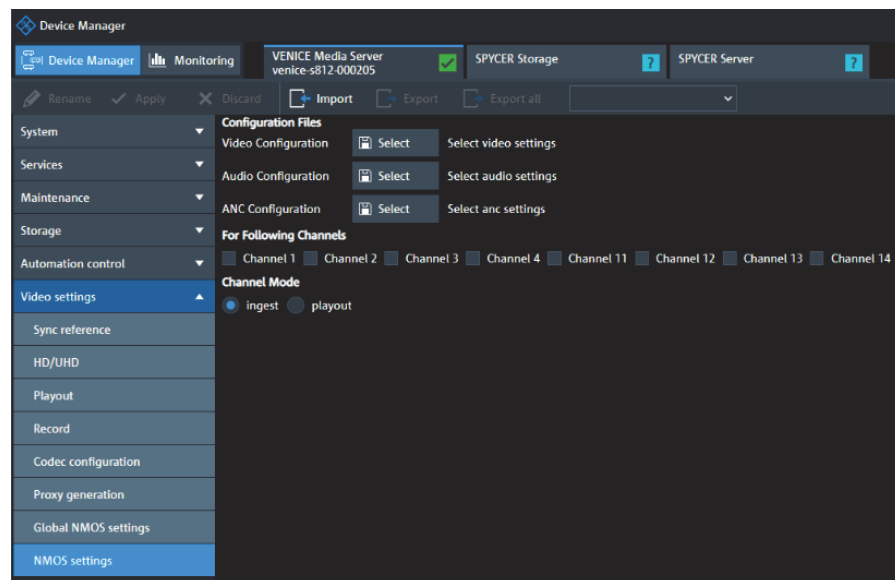

2. Import the JSON files with the NMOS configuration settings. There is one JSON file per data type, operation mode (playout or ingest), and channel.

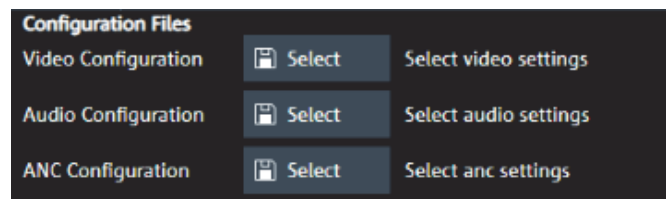

Please note that it is a good practice to include at least the channel index and maybe the name of the NMOS Node into the name of the resource. This simplifies the assignment of the stream to the corresponding channel.

3. Select the associated channel.

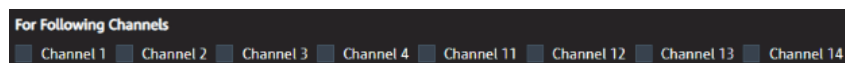

Channels 11,12,13,14 are available for the second video card (R&S VENICE S8 only).

## Integration into an IP Network

4. Select the channel mode (ingest or playout).

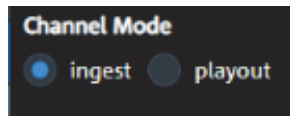

If the configuration file for a specific combination is missing or invalid, R&S VENICE S G3 automatically creates default resources. The NMOS name of those resources starts with the string **Default**.

The next sections provide detailed information about the structure and parameters of the audio, video and ANC configuration files.

**Video Configuration**

The following section provides a small example and also lists the entire JSON schema for video configuration.



The name scheme may change due to version control.

**Example for video configuration:**

```
{
  "nmosResourceName": "VeniceVideoChannel01",
  "usesSt2022-7": true,
  "deviceIPs": ["192.168.1.1", "192.168.1.2"],
  "multicastIPs": ["232.20.1.1", "232.20.1.2"],
  "multicastPorts": [50000, 50100],
  "videoColorimetry": "BT601",
  "transferCharacteristicSystem": "HLG"
}
```

*Parameters "deviceIPs", "multicastIPs", "multicastPorts", "videoColorimetry", and "transferCharacteristicSystem" are optional.*

**Complete JSON Schema for video configuration:**

```

{"$schema": "http://json-schema.org/draft-04/schema#",
  "type": "object",
  "properties": {
    "nmosResourceName": {
      "description": "Unique name of the NMOS resource used
for the creation of the NMOS resource IDs.",
      "type": "string",
      "default": "VeniceChannel"
    },
    "nmosResourceLabel": {
      "description": "NMOS label and description of the NMOS
resource.",
      "type": "string",
      "default": "VeniceChannel"
    },
    "usesSt2022-7": {
      "description": "Enable seamless protection switching
for the video NMOS resource.",
      "type": "boolean",
      "default": true
    },
    "deviceIPs": {
      "description": "Optional array of one or two device IP
addresses or interface names used for SMPTE2110. Use null for default
interfaces.",
      "type": ["array", "null"],
      "minItems": 1,
      "maxItems": 2,
      "items": {
        "type": "string",
        "oneOf": [
          {
            "pattern": "^rsip[0-1]s[0-4]$"
          },
          {
            "pattern": "^[0-9]{1,3}\\.[0-9]{1,3}\\.[0-9]{1,3}$"
          }
        ]
      }
    }
  }
}

```

## Integration into an IP Network

```
    },
    "multicastIPs": {
      "type": ["array", "null"],
      "minItems": 1,
      "maxItems": 2,
      "items": {
        "type": "string",
        "format": "ipv4"
      }
    },
    "multicastPorts": {
      "type": ["array", "null"],
      "minItems": 1,
      "maxItems": 2,
      "items": {
        "type": "integer",
        "minimum": 1,
        "maximum": 65535
      }
    },
    "videoColorimetry": {
      "type": "string",
      "enum": [
        "BT601",
        "BT709",
        "BT2020",
        "BT2100",
        "ST2065_1",
        "ST2065_3",
        "UNSPECIFIED",
        "XYZ"
      ]
    },
    "transferCharacteristicSystem": {
      "type": "string",
      "enum": [
        "SDR",
        "PQ", "HLG",
```



```

        "LINEAR",
        "BT2100LINPQ",
        "BT2100LINHLG",
        "ST2065_1",
        "ST428_1",
        "DENSITY",
        "UNSPECIFIED"
    ]
}
},
"required": [
    "nmosResourceName",
    "usesSt2022-7"
],
"additionalProperties": false
}

```

**ANC Configuration**

The following section provides a small example and also lists the entire JSON schema for ANC configuration.



The name scheme may change due to version control.

**Example for ANC configuration:**

```

{
  "nmosResourceName": "VeniceAncChannel01",
  "usesSt2022-7": true,
  "deviceIPs": ["192.168.1.1", "192.168.1.2"],
  "multicastIPs": ["232.20.1.1", "232.20.1.2"],
  "multicastPorts": [50000, 50100]
}

```

*Parameters "deviceIPs", "multicastIPs", and "multicastPorts" are optional.*

**Complete JSON Schema for ANC configuration:**

## Integration into an IP Network

```

{
  "$schema": "http://json-schema.org/draft-04/schema#",
  "type": "object",
  "properties": {
    "nmosResourceName": {
      "description": "Unique name of the NMOS resource used
for the creation of the NMOS resource IDs.",
      "type": "string",
      "default": "VeniceChannel"
    },
    "nmosResourceLabel": {
      "description": "NMOS label and description of the NMOS
resource.",
      "type": "string",
      "default": "VeniceChannel"
    },
    "usesSt2022-7": {
      "description": "Enable seamless protection switching for
the video NMOS resource.",
      "type": "boolean",
      "default": true
    },
    "deviceIPs": {
      "description": "Optional array of one or two device IP
addresses or interface names used for SMPTE2110. Use null for default
interfaces.",
      "type": ["array", "null"],
      "minItems": 1,
      "maxItems": 2,
      "items": {
        "type": "string",
        "oneOf": [
          {
            "pattern": "^rsip[0-1]s[0-4]$"
          },
          {
            "pattern": "^[0-9]{1,3}\\.[0-9]{1,3}\\.[0-9]{1,3}$"
          }
        ]
      }
    }
  }
}

```

```

},
  "multicastIPs": {
    "type": ["array", "null"],
    "minItems": 1,
    "maxItems": 2,
    "items": {
      "type": "string",
      "format": "ipv4"
    }
  },
  "multicastPorts": {
    "type": ["array", "null"],
    "minItems": 1,
    "maxItems": 2,
    "items": {
      "type": "integer",
      "minimum": 1,
      "maximum": 65535
    }
  }
},
"required": [
  "nmosResourceName",
  "usesSt2022-7"
],
"additionalProperties": false
}

```

**Audio Configuration** The JSON audio (routing) schema used by R&S VENICE S defines the structure of the audio configuration JSON file. It specifies a list of up to 16 audio streams. Beside the name of the stream and the use of ST2022-7, each audio stream comprises a stream index, the number of audio channels, audio labels, audio symbols, and audio routings.

**Example for the configuration of one stereo audio stream:**

## Integration into an IP Network

```
{
  "$schema": "http://json-schema.org/draft-04/schema#",
  "definitions": {
    "multiAudioStreamMapping": {
      "type": "object",
      "required": [
        "streamChannelIndex",
        "bufferChannelIndex"
      ],
      "additionalProperties": false,
      "properties": {
        "streamChannelIndex": {
          "type": "integer",
          "minimum": 0,
          "maximum": 7
        },
        "bufferChannelIndex": {
          "type": "integer",
          "minimum": 0,
          "maximum": 15
        }
      }
    },
    "audioStream": {
      "type": "object",
      "required": [
        "index",
        "name",
        "channels",
        "routing",
        "labels"
      ],
      "additionalProperties": false,
      "properties": {
        "index": {
          "type": "integer",
          "minimum": 0,
          "maximum": 15
        }
      }
    }
  }
}
```

```
{
  "audioStreams": [
    {
      "channels": 2,
      "index": 0,
      "labels": [
        "Left german",
        "Right german"
      ],
      "name": "Audio01-Channel01",
      "routing": [
        {
          "bufferChannelIndex": 0,
          "streamChannelIndex": 0
        },
        {
          "bufferChannelIndex": 1,
          "streamChannelIndex": 1
        }
      ],
      "symbols": [
        "L",
        "R"
      ],
      "usesSt2022-7": true,
      "deviceIPs": [
        "192.168.1.1",
        "192.168.1.2"
      ],
      "multicastIPs": [
        "232.20.1.1",
        "232.20.1.2"
      ],
      "multicastPorts": [
        50000,
        50100
      ]
    }
  ]
}
```

## Integration into an IP Network

*Parameters "symbols", "usesSt2022-7", "deviceIPs", "multicastIPs", and "multicastPorts" are optional.*

<b>bufferChannelIndex</b>	The index of the internal audio channel from zero to 15.
<b>streamChannelIndex</b>	The index of the audio channel of the stream from zero to number of channels minus one.

**Ingest:**

For ingest, the **streamChannelIndex** is routed to the **bufferChannelIndex** where the **bufferChannelIndex** needs to be unique over all defined streams.

**Playout:**

For playout, the **bufferChannelIndex** is routed to the **streamChannelIndex** where the **streamChannelIndex** needs to be unique within each audio stream. Without the restrictions, two outputs would be mapped to the same input, which would require a mixing of the audio signals, which is not implemented so far.



Note that senders originally provide a stream with number of channels as defined by the parameter **channels**. However, receivers can also be connected to senders with a different number of channels. For receivers, the parameter **channels** defines the number of audio channels routed into the recorded file. If the number of received audio channels is greater than the number of channels of the stream, only the first number of **channels** is routed to the file. If the number of received channels is smaller, the missing channels contain zero samples.

**Complete JSON Schema for audio configuration:**

```
{
  "$schema": "http://json-schema.org/draft-04/schema#",
  "definitions": {
    "multiAudioStreamMapping": {
      "type": "object",
      "required": [
        "streamChannelIndex",
        "bufferChannelIndex"
      ],
      "additionalProperties": false,
      "properties": {
        "streamChannelIndex": {
          "type": "integer",
          "minimum": 0,
          "maximum": 7
        },
        "bufferChannelIndex": {
          "type": "integer",
          "minimum": 0,
          "maximum": 15
        }
      }
    },
    "audioStream": {
      "type": "object",
      "required": [
        "index",
        "name",
        "channels",
        "routing",
        "labels"
      ],
      "additionalProperties": false,
      "properties": {
        "index": {
          "type": "integer",
          "minimum": 0,
          "maximum": 15
        }
      }
    }
  }
}
```

## Integration into an IP Network

```

        "name": {
            "description": "Unique name of the NMOS
resource used for the creation of the NMOS resource IDs.",
            "type": "string"
        },
        "label": {
            "description": "NMOS label and description
of the NMOS resource.",
            "type": "string"
        },
        "usesSt2022-7": {
            "description": "Enable seamless protection
switching for this stream.",
            "type": ["boolean", "null"],
            "default": true
        },
        "deviceIPs": {
            "description": "Optional array of one or
two device IP addresses or interface names used for SMPTE2110. Use null for
default interfaces.",
            "type": ["array", "null"],
            "minItems": 1,
            "maxItems": 2,
            "items": {
                "type": "string",
                "oneOf": [
                    {
                        "pattern": "^nsip[0-1]s[0-
4]$"
                    },
                    {
                        "pattern": "^[0-9]{1,3}\\.[0-9]{1,3}\\.[0-9]{1,3}$"
                    }
                ]
            }
        },
        "multicastIPs": {
            "type": ["array", "null"],
            "minItems": 1,
            "maxItems": 2,

```



```
        "items": {
            "type": "string",
            "format": "ipv4"
        }
    },
    "multicastPorts": {
        "type": ["array", "null"],
        "minItems": 1,
        "maxItems": 2,
        "items": {
            "type": "integer",
            "minimum": 1,
            "maximum": 65535
        }
    },
    "channels": {
        "type": "integer",
        "minimum": 1,
        "maximum": 8
    },
    "routing": {
        "type": "array",
        "minItems": 1,
        "maxItems": 8,
        "items": {
            "$ref":
"#/definitions/multiAudioStreamMapping"
        }
    },
    "labels": {
        "type": "array",
        "items": {
            "description": "Label for this
channel (free text)",
            "type": "string"
        }
    },
    "symbols": {
```

## Integration into an IP Network

```

        "type": ["array", "null"],
        "items": {
channel (from VSF TR-03 Appendix A)",
            "description": "Symbol for this",
            "type": "string",
            "oneOf": [
                {
                    "enum": [
                        "L",
                        "R",
                        "C",
                        "LFE",
                        "Ls",
                        "Rs",
                        "Lss",
                        "Rss",
                        "Lrs",
                        "Rrs",
                        "Lc",
                        "Rc",
                        "Cs",
                        "HI",
                        "VIN",
                        "M1",
                        "M2",
                        "Lt",
                        "Rt",
                        "Lst",
                        "Rst",
                        "S"
                    ]
                },
                {
                    "pattern": "^NSC(00[1-9]|0[1-9][0-9]|1[0-1][0-9]|12[0-7])$",
                    "description":
                    "Numbered Source Channel"
                },
                {
                    "pattern": "^U(0[1-9]|[1-5][0-9]|6[0-4])$",

```

```

        "Lst",
        "Rst",
        "S"
    ]
},
{
    "pattern": "^NSC(00[1-9]|0[1-9][0-9]|1[0-1][0-9]|12[0-7])$",
    "description": "Numbered Source Channel"
},
{
    "pattern": "^U(0[1-9]|[1-5][0-9]|6[0-4])$",
    "description": "Undefined channel"
}
]
}
}
},
"description": "List of IP audio routing configurations per stream.",
"type": "object",
"properties": {
    "audioStreams": {
        "type": "array",
        "minItems": 1,
        "maxItems": 16,
        "items": {
            "$ref": "#/definitions/audioStream"
        }
    }
},
"required": [
    "audioStreams"
],
"additionalProperties": false
}

```

## Integration into an IP Network

```
  ],  
  "additionalProperties": false  
}
```

# Working with the R&S Installer (RSI)

The Rohde & Schwarz Installer (RSI) is used to install the entire software environment required to operate R&S systems. The RSI is an executable that needs to run on a computer with a Windows operating system in order to update one or more R&S systems over the network.

This chapter is divided into the following sections:

- Types of RSI Packages (page 146)
- Using an RSI (page 147)
- RSI Troubleshooting (page 149)

## Types of RSI Packages

There are currently three different types of RSI packages. Please refer to the GLORIS site for your system at <https://gloris.rohde-schwarz.com> and download the linked RSI packages.



When updating a system, the RSI packages have to be installed in the following specific order according to their type:

- 1 **File system RSI.** This contains a new version of the file system, either Spectrum Scale or StorNext.
- 2 **Operating system RSI.** This contains fixes and improvements for the operating system.
- 3 **Software RSI.** This updates the R&S software such as R&S@VENICE and Spycer.



Please be aware that the system will automatically reboot within ten minutes after the installation of a file system or operating system RSI.

## Using an RSI

The RSI package is a Windows executable that can remotely update R&S systems in the network.

-  Always make sure to install the RSI packages in the correct order according to their type, see "Types of RSI Packages" (page 146).

Perform the following steps:

1. On a Windows system, start the installer with a double click.
  - ▶ First, the version information of the current installer is provided.

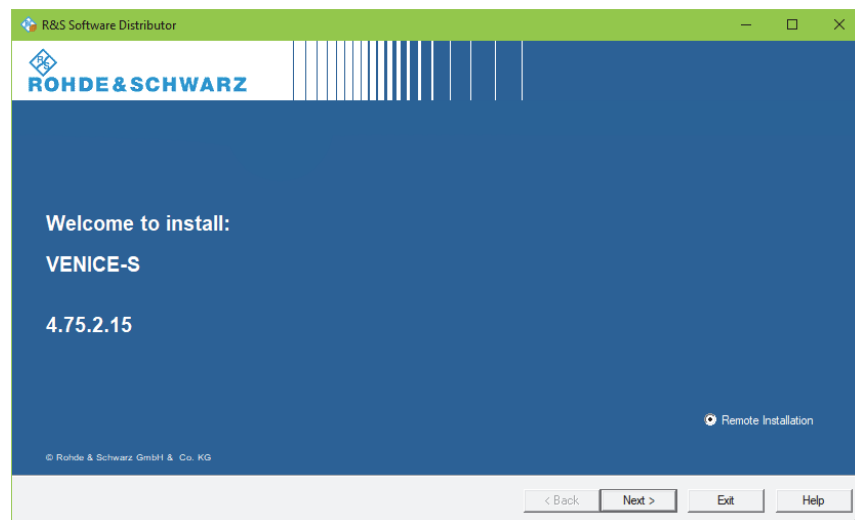

2. Click the **Next** button.
  - ▶ The installer will list all software (operating system, drivers and tools) which will be updated.

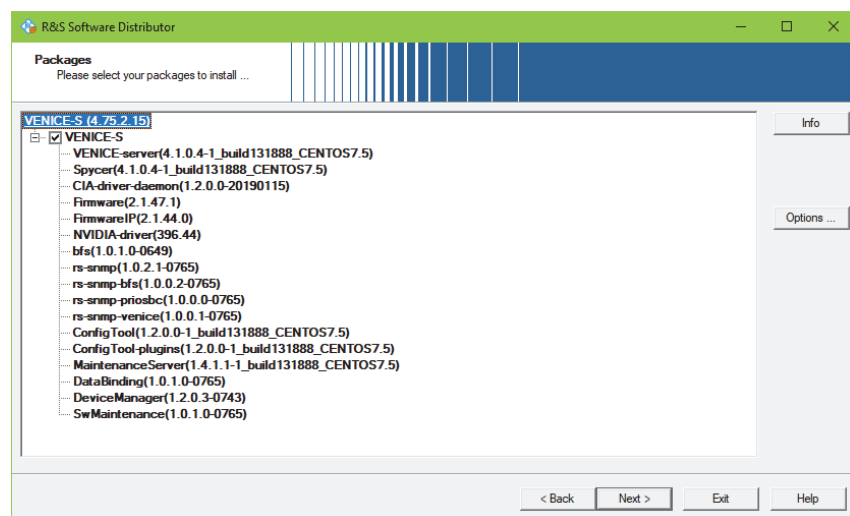

## Using an RSI

3. Click **Next** to proceed to the next section.
  - ▶ A list is shown with all newer R&S systems detected in the network. In the first column, you can select one or more systems to be updated.

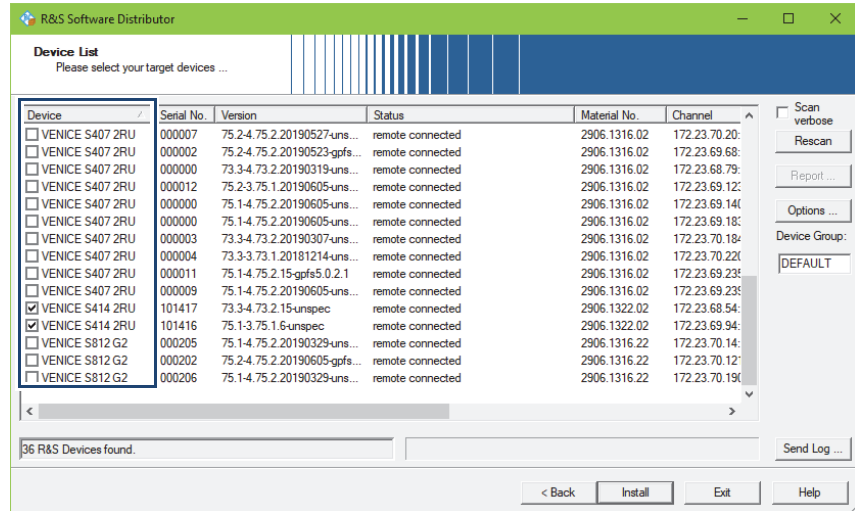

4. Click **Install** to start the installation. The current status will be shown in the Status column.



Please be aware that the system will automatically reboot within ten minutes after the installation of a file system or operating system RSI.



## RSI Troubleshooting

This section provides information on what to do in case an RSI installation fails.

### Logs

Logs of the installation process are created on the systems involved. The logs are located under `/var/log/rohde-schwarz/swupdate/rsi-installer_<YYYY-MM-DD>_<HH-MM-SS>.txt`.

### Error Codes

If errors occur during the installation, the RSI will show error codes displayed on the monitor, without having to open the log files. Some errors can be rectified on site while others require to contact the R&S support department for assistance. If the latter is the case, please provide the code number of the error(s) in question.

Error code	Message	Description & possible solution
5	Installer already running!	-
30	Failed unpacking Windows client installers!	Disk volume is full or installation packages are defective.
31	Failed importing new packages!	Disk volume is full or installation packages are defective.
32	Failed updating!	Disk volume is full or installation packages are defective.
33	Failed installing meta package!	The meta package of the product is defective or required packages are missing.
34	Image version is 'X', must be at least 'Y'!	Operating system image is not compatible with the RSI. Possible cause is the attempt to install a new RSI on an obsolete/outdated image.
35	Machine UUID '/etc/opt/rohde-schwarz/machine-uuid' is missing!	Installation failed on the system. Try executing <code>fbms-setup.sh</code> .
36	System configuration '/etc/opt/rohde-schwarz/swupdate.conf' is missing!	Installation failed on the system. Try executing <code>fbms-setup.sh</code> .

## RSI Troubleshooting

Error code	Message	Description & possible solution
37	This RSI is for CentOS 'X', but this system is running 'Y'!	The CentOS version of the system is not compatible with the RSI. Either update the system or use an appropriate RSI.
38	Package 'zvbi' is not installed. Please contact the support!	The 'zvbi' package has to be installed manually. Please contact R&S support department.
39	NVIDIA driver 'X' is missing!	Please contact R&S support department.
40	Failed installing NVIDIA driver!	More details can be found in the log file on the system. Please contact R&S support department.
41	Failed configuring NVIDIA driver!	nvidia-smi -e 0 command has failed. Call up the command in a shell, gather the information details and contact R&S support department.
42	zip_unpack() failed: argument missing (1: X, 2: Y)	Not enough parameters for the internal RSI execution. Please contact R&S support department.
43	Failed unpacking ZIP file!	Unpacking process failed. More details can be found in the log file on the system. Please contact R&S support department.
44	Needed hotfix is missing!	More details can be found in the log file on the system. Please contact R&S support department.
45	The new version is older than the currently installed version!	A downgrade to an older version is not possible.
46	Unpacking tar.gz archives failed!	Unpacking the (rus-configd-plugins rus-extra).tar.gz archive has failed. Please contact R&S support department.
47	CentOS version is 'X', but must be at least 'Y'!	CentOS version is outdated. Upgrade first the operating system.

Error code	Message	Description & possible solution
48	CentOS version is 'X', but must be lower than 'Y'!	The newer CentOS version is not compatible with this outdated RSI. Use a newer RSI version.
49	Please perform a manual downgrade before installing this version!	A downgrade is required. All packages must be uninstalled using '/opt/rohde-schwarz/fbms-uninstall.sh uninstall'

RSI Troubleshooting

# Maintenance

This chapter is divided into the following sections:

- "Safety Instructions" (page 154)
- "Removing and Mounting the System Cover" (page 156)
- "Replacing a Power Supply Unit" (page 158)
- "Replacing a Hot Swappable Hard Drive" (page 160)
- "Replacing a Cooling Fan Assembly" (page 162)
- "Replacing a Cooling Fan" (page 163)
- "Replacing the Internal USB Memory Key" (page 165)

## Safety Instructions

**⚠ WARNING****Risk of Injury**

Lifting heavy systems can lead to serious injury.

**Do not attempt to lift the system by yourself. Whenever you need to lift the system, get others to assist you.**

**⚠ WARNING****Electric Shock**

Opening or removing the system cover while the system is powered on may expose you to a risk of electric shock.

**Don't open or remove the system while the system is powered on.**

**NOTICE****System Damage**

Operating the system without the system cover can result in component damage.

**Do not operate the system without the cover for a duration exceeding five minutes.**

**⚠ CAUTION****Warranty Claims**

Many repairs may only be done by a certified service technician. You should only perform troubleshooting and simple repairs as authorized in your product documentation, or as directed by the online or telephone service and support team. Damage due to servicing that is not authorized by Rohde & Schwarz is not covered by your warranty.

**Read and follow the safety instructions that are shipped with your product.**

**NOTICE****Electrostatic Discharge (ESD)**

Computer hardware contains components that are sensitive to electrostatic discharge. If you touch them without precautionary measures, they can be destroyed.

**Use a wrist strap connected to ground when accessing electronic parts and take care of grounding the system. Avoid touching the internal components of the computer system and the video board whenever possible.**

**NOTICE****Proper Operation and Cooling**

To ensure proper operation and cooling, all bays in the system and system fans must be populated always with either a component or a plate.

**Install a component or a plate if necessary.**

## Removing and Mounting the System Cover

## Removing and Mounting the System Cover

### Removing the System Cover

- Requirements:
- ✓ Follow the safety guidelines listed in chapter “Safety Instructions” on page 154 and chapter “Safety and regulatory information” on page 7.
  - ✓ If installed, remove the front plate.
  - ✓ If applicable, remove the system from the rack.

Perform the following steps:

1. Rotate the latch release lock counter clockwise to the unlocked position.
2. Lift the latch toward the back of the system.  
The system cover slides back and the tabs on the system cover disengage from the slots on the chassis.



The position of the latch may vary depending on the configuration of your system.

3. Hold the cover on both sides, and lift the cover away from the system.

### Installing the System Cover

- Requirements:
- ✓ Follow the safety guidelines listed in chapter “Safety Instructions” on page 154 and chapter “Safety and regulatory information” on page 7.
  - ✓ Ensure that all internal cables are connected and placed out of the way and no tools or extra parts are left inside the system.



## Removing and Mounting the System Cover

Perform the following steps:

1. Align the slots on the system cover with the tabs on the chassis.
2. Push the system cover latch down to move the system cover into the closed position.
  - ▶ The system cover slides forward and the tabs on the system cover engage with the slots on the chassis. The system cover latch locks into place when the system cover engages with the slots on the chassis.
3. Rotate the latch release lock clockwise to the locked position.



4. If applicable, install the system into the rack.
5. If removed, install the front plate.
6. Reconnect the peripherals and connect the system to the electrical outlet.
7. Turn on the system, including any attached peripherals.

## Replacing a Power Supply Unit

**⚠ CAUTION****PSU Mismatch Conditions**

Mixing PSUs from previous generations of systems can result in a PSU mismatch condition or failure to turn on.

**If two PSUs are used, they must be of the same maximum output power.**

**For AC PSUs, use only PSUs with the Extended Power Performance (EPP) label on the back.**

**⚠ CAUTION****Data Loss**

The system needs one power supply for normal operation.

**On power-redundant systems, remove and replace only one power supply at a time in a system that is powered on.**



You may have to unlatch and lift the optional cable management arm if it interferes with power supply removal.

**Requirements:**

- ✓ Follow the safety guidelines listed in "Safety Instructions" on page 154 and "Safety and regulatory information" (page 7).
- ✓ If applicable, remove the system from the rack.
- ✓ Verify that both PSUs are of the same type and have the same maximum output power, that is listed on the PSU label (shown in watts).

## Replacing a Power Supply Unit

Perform the following steps:

1. Disconnect the power wires from the power source and the connector from the PSU you intend to remove.
2. Press the release latch and slide the PSU out of the chassis by using the PSU handle.



3. Slide the new PSU into the chassis until the PSU is fully seated and the release latch snaps into place.



4. If you have unlatched the cable management arm, re-latch it.
5. Connect the power cable to the PSU and plug the cable into a power outlet.



When installing, hot-swapping, or hot-adding a new PSU, wait for 15 seconds for the system to recognize the PSU and determine its status. The PSU status indicator turns green to signify that the PSU is functioning properly.

6. Secure the cable with the strap.
7. If applicable, install the system into the rack.
8. If removed, install the front plate.

## Replacing a Hot Swappable Hard Drive

## Replacing a Hot Swappable Hard Drive

- Requirements:
- ✓ Follow the safety guidelines listed in chapter “Safety Instructions” on page 154 and chapter “Safety and regulatory information” on page 7.
  - ✓ If installed, remove the front plate.

Perform the following steps:

1. Press the release button to open the hard drive carrier release handle.

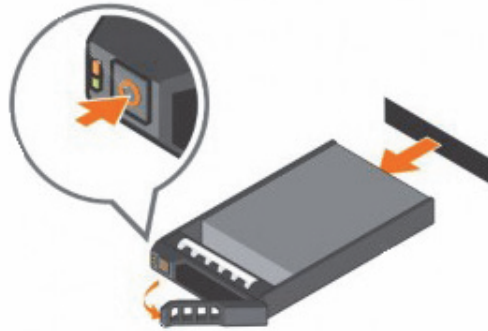

2. Slide the hard drive out of the hard drive slot.  
→ If you are not replacing the hard drive immediately, insert a hard drive blank in the empty hard drive slot.

**NOTICE****Cooling Problems**

To maintain proper system cooling, all empty hard drive slots must have hard drive blanks installed.

**Install a hard drive blank if necessary.**

**NOTICE****Data Loss**

Using not tested hard drives can result in loss of data.

**Use only hard drives that have been tested and approved for use with the hard drive backplane.**

**NOTICE****Damaged Carrier**

Inserting a hard drive carrier and attempting to lock its handle next to a partially installed carrier can damage the partially installed carrier's shield spring and make it unusable.

**When installing a hard drive, ensure that the adjacent drives are fully installed.**

## Replacing a Hot Swappable Hard Drive

**NOTICE****Data Loss**

When a replacement hot swappable hard drive is installed and the system is powered on, the hard drive automatically begins to rebuild. Any data on the replacement hard drive is immediately lost after the hard drive is installed.

**Make absolutely sure that the replacement hard drive is blank or contains data that you wish to have overwritten.**



Combining SAS and SATA hard drives in the same RAID volume is not supported.

3. Install a hard drive in the hard drive carrier.
4. Press the release button on the front of the hard drive carrier and open the hard drive carrier handle.
5. Insert the hard drive carrier into the hard drive slot until the carrier connects with the backplane.



6. Close the hard drive carrier handle to lock the hard drive in place.
7. Turn on the hard drive.



8. If removed, install the front plate.

## Replacing a Cooling Fan Assembly

## Replacing a Cooling Fan Assembly

- Requirements:
- ✓ Follow the safety guidelines listed in chapter “Safety Instructions” on page 154 and chapter “Safety and regulatory information” on page 7.
  - ✓ If applicable, remove the system from the rack.
  - ✓ Remove the system cover as described in chapter “Removing the System Cover” on page 156.

Perform the following steps:

1. Unlock the cooling fan assembly from the chassis by lifting the release levers.
2. Lift the cooling fan assembly out of the chassis.

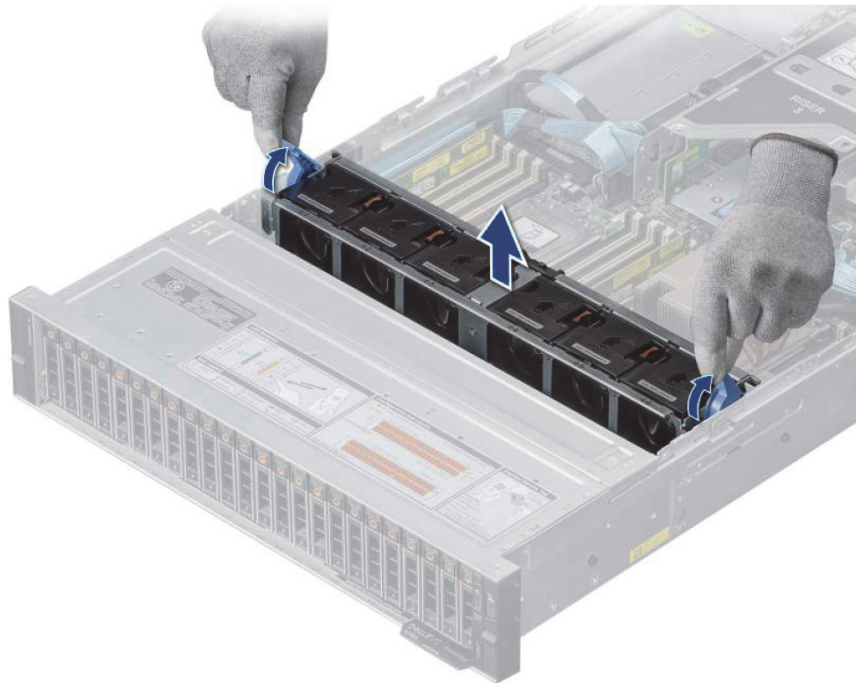

3. Align the slots on the cooling fan assembly with the guide pins on the chassis.
4. Slide the new cooling fan assembly into the chassis.

## Replacing a Cooling Fan Assembly

5. Lock the new cooling fan assembly into the chassis by lowering the release levers until firmly seated.

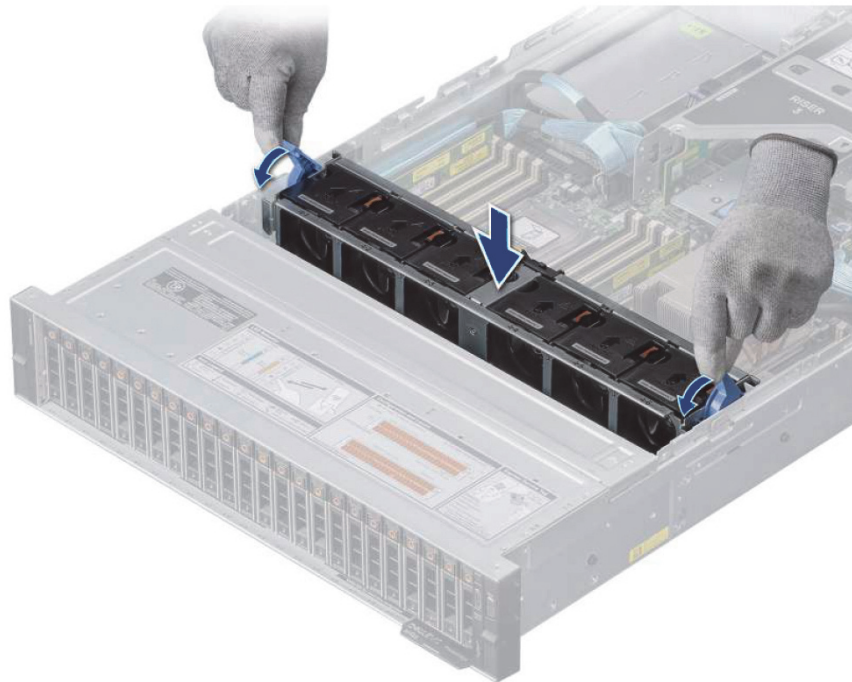

6. Install the system cover as described in chapter “Installing the System Cover” on page 156.

## Replacing a Cooling Fan

- Requirements:
- ✓ Follow the safety guidelines listed in chapter “Safety Instructions” on page 154 and chapter “Safety and regulatory information” on page 7.
  - ✓ If applicable, remove the system from the rack.
  - ✓ Remove the system cover as described in chapter “Removing the System Cover” on page 156.

### **CAUTION**

#### **Cooling Problems**

The cooling fans are hot-swappable, but to maintain proper cooling while the system is on, it is important to replace only one fan at a time.

**Replace only one fan at a time.**



## Replacing a Cooling Fan Assembly

Perform the following steps:

1. Press the fan release tab and lift the cooling fan out of the cooling fan assembly.

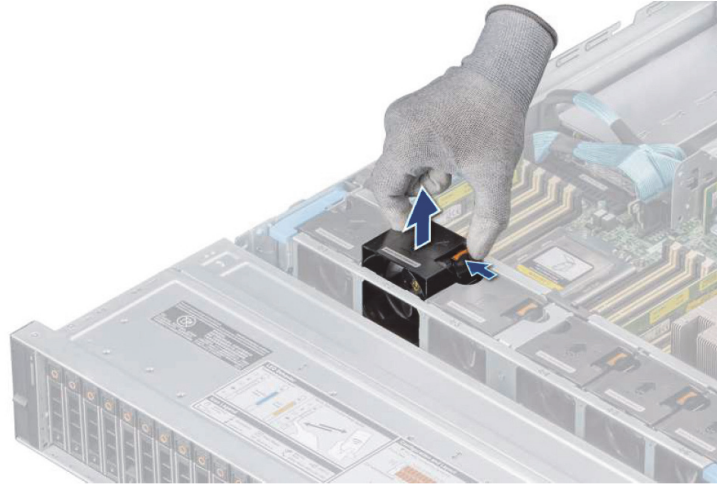

2. Align the connector at the base of the cooling fan with the connector on the system board.
3. Slide the new cooling fan into the securing slot until the tab locks into place.

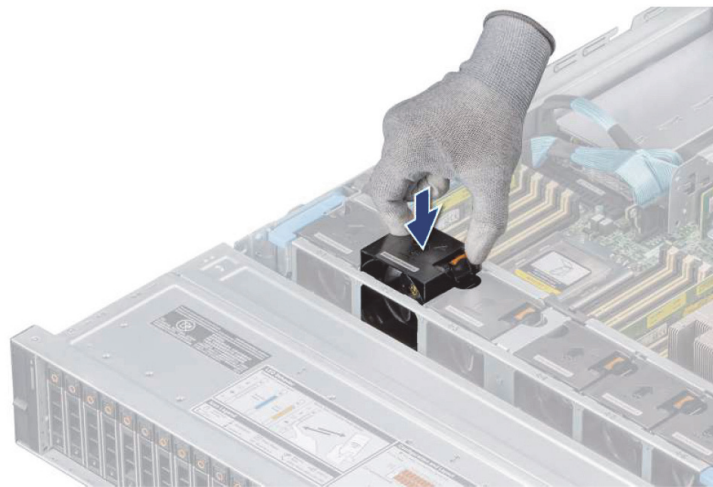

4. If applicable, install the system into the rack.
5. Install the system cover as described in chapter "Installing the System Cover" on page 156.



## Replacing the Internal USB Memory Key

- Requirements:
- ✓ Follow the safety guidelines listed in chapter “Safety Instructions” on page 154 and chapter “Safety and regulatory information” on page 7.
  - ✓ If installed, remove the front plate.
  - ✓ If applicable, remove the system from the rack.
  - ✓ Remove the system cover as described in chapter “Removing the System Cover” on page 156.

Perform the following steps:

1. Remove the USB memory key from the USB port.

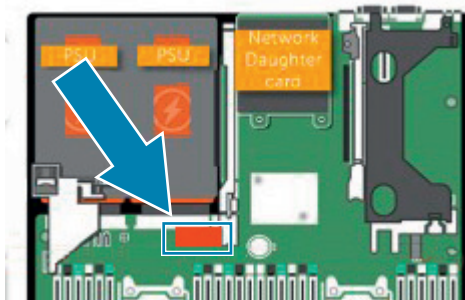

2. Insert the replacement USB memory key into the USB port.
3. If applicable, install the system into the rack.
4. If removed, install the front plate.
5. While booting, press **[F2]** to enter System Setup and verify that the system detects the USB memory key.
6. Install the system cover as described in chapter “Installing the System Cover” on page 156.

Replacing the Internal USB Memory Key



# Transport

This chapter includes the following sections:

- "Safety Notes" (page 168)
- "Packing the System" (page 169)

## Safety Notes

R&S VENICE S G3 is a very sensitive device. Handle it with great care. Especially the disks of the system must be handled with great care.

	Fragile. Avoid shocks or vibrations. For longer distances use a lifting device.
	Keep dry.

---

### **DANGER**

#### **Risk of injury while handling component with heavy weight**

Improper handling of the VENICE S can cause substantial damage to personnel and equipment by falling or overturning.

**VENICE S must be lifted and carried by two people on both sides. It is preferable to use lifting devices and means of transport. Beware of the crushing hazard when working with heavy loads.**

---

## Packing the System

Perform the following steps:

**NOTICE****Transportation Damage**

Warranty will be void if not using the original packing for transportation.

Keep the original packing and use it in case of transportation. If you do not have the original packing anymore, use a similar structured packing for transportation. **Rohde & Schwarz** cannot be held liable for transportation damages.

1. Wrap the video system in foil.

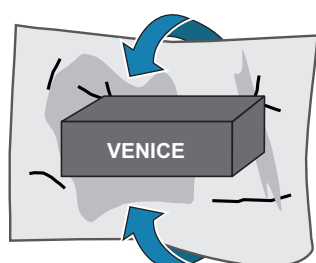

2. Pack the video system in box A with foam.

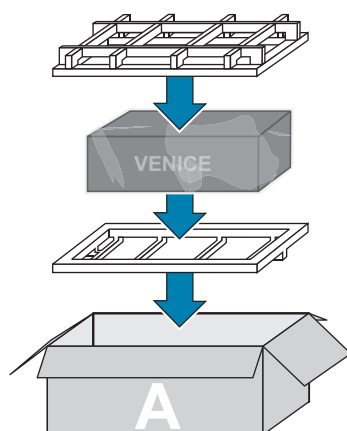

## Packing the System

3. Pack the accessories.

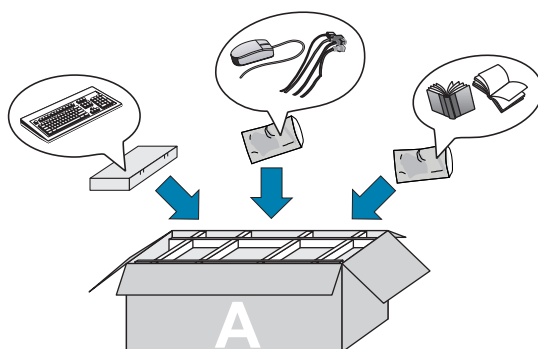

4. Add filling material so that the contents of your package are unable to move around inside the box.
5. Close box A.

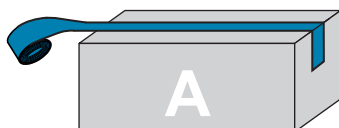

The system has been packed.

# Troubleshooting

This chapter includes the following section:

- "Safety First - For you and your System" (page 172)
- "Troubleshooting External Connections" (page 173)
- "Troubleshooting the Video Subsystem" (page 174)
- "Troubleshooting a USB Device" (page 175)
- "Troubleshooting Power Supply Units" (page 176)
- "Troubleshooting Power Source Problems" (page 176)
- "Power Supply Unit Problems" (page 176)
- "Troubleshooting Cooling Problems" (page 177)
- "Troubleshooting Cooling Fans" (page 177)
- "Troubleshooting an Internal USB Key" (page 178)
- "Restarting a Single Channel" (page 179)
- "Disk Space Limit" (page 180)

## Safety First - For you and your System

---

**⚠ CAUTION****Warranty Claims**

Many repairs may only be done by a certified service technician. You should only perform troubleshooting and simple repairs as authorized in your product documentation, or as directed by the online or telephone service and support team. Damage due to servicing that is not authorized by Rohde & Schwarz is not covered by your warranty.

**Read and follow the safety instructions that are shipped with your product.**

---



## Troubleshooting External Connections

Before troubleshooting any external devices, ensure that all external cables are securely attached to the external connectors on your system before troubleshooting any external devices.

## Troubleshooting the Video Subsystem

Perform the following steps:

1. Check the cable connections (power and display) to the monitor.
2. Check the video interface cabling from the system to the monitor.
3. Run the appropriate diagnostic test.

If the tests run successfully, the problem is not related to video hardware. If the tests fail, contact your local vendor or Rohde & Schwarz directly.

## Troubleshooting a USB Device

Follow these steps to troubleshoot a USB keyboard or mouse. For other USB devices, contact your local vendor or Rohde & Schwarz GmbH & Co. KG directly.

Perform the following steps:

1. Disconnect the keyboard and/or mouse cables from the system and reconnect them.
2. If the problem persists, connect the keyboard and/or mouse to another USB port on the system.
3. If the problem is resolved, restart the system, enter System Setup, and check if the non-functioning USB ports are enabled.



Older operating systems may not support USB 3.0.

4. Check if USB 3.0 is enabled in System Setup. If enabled, disable it and see if the issue is resolved.
5. If the problem is not resolved, replace the keyboard and/or mouse with a known working keyboard or mouse.

If all troubleshooting fails, contact your local vendor or Rohde & Schwarz directly.

## Troubleshooting Power Supply Units

### Troubleshooting Power Source Problems

Perform the following steps:

1. Press the power button to ensure that your system is turned on. If the power indicator does not glow when the power button is pressed, press the power button firmly.
2. Plug in another working power supply unit to ensure that the system board is not faulty.
3. Ensure that no loose connections exist.  
For example, loose power cables.
4. Ensure that the power source meets applicable standards.
5. Ensure that there are no short circuits.
6. Have a qualified electrician check the line voltage to ensure that it meets the needed specifications.

### Power Supply Unit Problems

Perform the following steps:

1. Ensure that no loose connections exist.  
For example, loose power cables.
2. Ensure that the power supply handle/LED indicates that the power supply is working properly.
3. If you have recently upgraded your system, ensure that the power supply unit has enough power to support the new system.
4. If you have a redundant power supply configuration, ensure that both the power supply units are of the same type and wattage.  
If the LED You may have to upgrade to a higher wattage power supply unit.
5. Ensure that you use only power supply units with the Extended Power Performance (EPP) label on the back.
6. Reseat the power supply unit.  
**NOTE: After installing a power supply unit, allow several seconds for the system to recognize the power supply unit and determine if it is working properly.**

If the problem persists, contact your local vendor or Rohde & Schwarz directly.

## Troubleshooting Cooling Problems

Ensure that the following conditions exist:

- System cover, cooling shroud, EMI filler panel, memory module blank, or back filler bracket is not removed.
- Ambient temperature is not higher than the system specific ambient temperature.
- External airflow is not obstructed.
- A cooling fan is not removed or has not failed.
- The expansion card installation guidelines have been followed.

### Troubleshooting Cooling Fans

- Requirements:
- ✓ Follow the safety guidelines listed in chapter "Safety Instructions" on page 154 and chapter "Safety and regulatory information" on page 7.
  - ✓ If installed, remove the front plate.
  - ✓ If applicable, remove the system from the rack.
  - ✓ Remove the system cover as described in chapter "Removing the System Cover" on page 156.



The fan number is referenced by the systems management software. In the event of a problem with a particular fan, you can easily identify and replace it by noting down the fan numbers on the cooling fan assembly.

Perform the following steps:

1. Reseat the fan or the fan's power cable.
2. Install the system cover as described in chapter "Installing the System Cover" on page 156.
3. Restart the system.

If the problem persists, contact your local vendor or Rohde & Schwarz directly.

## Troubleshooting an Internal USB Key

Perform the following steps:

1. Enter System Setup and ensure that the **USB key port** is enabled on the **Integrated Devices** screen.
2. Turn off the system and attached peripherals, and disconnect the system from the electrical outlet.
3. Remove the system cover as described in "Removing the System Cover" on page 156.
4. Locate the USB key and reseal it.
5. Install the system cover as described in "Installing the System Cover" on page 156.
6. Turn on the system and attached peripherals, and check if the USB key is functioning.
7. If the problem is not resolved, repeat step 2 and step 3.
8. Insert a known working USB key.
9. Install the system cover as described in "Installing the System Cover" on page 156.

If the problem persists, contact your local vendor or Rohde & Schwarz directly.

## Restarting a Single Channel

Currently, restarting a single VENICE channel is possible only via terminal. This section describes the procedure of restarting a single channel without having to restart the rest of the adjacent channels.

Perform the following steps:

1. If using a Windows system, make sure a SSH client (e.g PuTTY) is installed which will allow you to access a remote Linux based VENICE system.
2. In the command prompt, log in to the VENICE server.

Systems built before 2020	<b>USERNAME:</b> root <b>PASSWORD:</b> password
Systems built after 2020	<b>USERNAME:</b> root <b>PASSWORD:</b> [serial number of the device].

► After login the command prompt should look like this:  
**root@[name-of-the-system]**

3. Stop the desired channel with `/opt/rohde-schwarz/venice stop [channel number]`.

```
[root@venice-s414-101417 ~]# /opt/rohde-schwarz/Venice/script/venice stop 2
Stopping veniceserver on channel 2 (PORT=4712) [pid:36233]...
veniceserver on channel 2 (PORT=4712)
is stopped. [ OK ]
Stopping avus on channel 2 (PORT=4212) [pid:34914] ...
is stopped. [ OK ]
purging avatars
```

4. Start the channel again with `/opt/rohde-schwarz/venice start [channel number]`.

```
[root@venice-s414-101417 ~]# /opt/rohde-schwarz/Venice/script/venice start 2
Failed to LOAD device config! Error: 10
Starting avus on channel 2 (PORT=4212) ...
NUMACTL: 'numactl --interleave=all -- '
is started. [ OK ]
Starting veniceserver on channel 2 (PORT=4712) ...
NUMACTL: 'numactl --interleave=all -- '
is started. [ OK ]
```



The error message "Failed to load device config" is not relevant in that case and can be ignored.

## Disk Space Limit

To ensure smooth operation, FIMS reports a disk full message in case a certain free space limit is exceeded during operation. The limit size is not fixed but rather calculated dynamically depending on the storage capacity currently in use. It is calculated based on the following formula:

**DiskLimit = MIN(300GB, MAX(10GB, DISK\_SIZE\*1%) ) -> 1%**  
of disk space but not smaller than 10 GB and not greater than 300 GB.



# Index

## A

Adapter cable	
Pins	57
Administration	95
ANC	23
Aspect ratio	25
Audio routing	30

## B

Back panel	40
Backup image	99
Bezel	36
Button	
Power	38
System identification	40

## C

Cable	
Lynx CBL-AES1604	59
CC	23
Channel assignment	45
Channel configuration	22
Chassis front	36
Closed caption	24
Configuration	71, 95
configuration	
subtitles	92, 93
Configure	
Channels	22
Configuring	77
Control panel	
Left	37
Right	37
Control VENICE S	88
Conversion	
AFD	26
Downconvert	44
Cooling fan	
Replace	163
Troubleshooting	177
Cooling fan assembly	52
Replace	162
Cooling fans	53
Cooling problems	177
Cover	
Install	156
Remove	156

## D

DB-15 connector	57
-----------------	----

## DB9-connector

Pins	57
Digital video signal	45
Documentation	18
DolbyE	30
Downconvert	41, 43
Conversion	44
D-Sub 9	57
Pins	57
Dynamic IP	77

## E

Ethernet connector	41
External connections	
Troubleshooting	173

## F

Fan	
Replace	163
Features	22
File management	87
Front	36
Front plate	36
Function	20

## H

Hard drive	36
Indicator codes	39
Indicators	39
Replacing	160
Hard drives	38
HD	22
Channel assignment	46, 47
HD Sub-D connector	
LTC In/Out	55

## I

iDRAC Direct	37
iDRAC8 Enterprise port	40
Image processing	30
In-/Output	45
Indicator codes	
Hard drives	39
NIC	49
PSU status	42
Information tag	36
Ingesting content	85
Inside	51
Installation	71, 72

- Installing
  - System cover ..... 156
- IP
  - Dynamic ..... 77
  - Static ..... 77
- IP settings ..... 119
  
- L**
- LTC in/out ..... 41
- Lynx CBL-AES1604
  - Pins ..... 59
  
- M**
- Maintenance ..... 153
  - System cover ..... 156
- Master/Slave control ..... 43
- Memory key
  - Replace ..... 165
- Models ..... 21
  
- N**
- Network ports ..... 60
- NIC
  - Connectors ..... 49
  - Indicator ..... 49
  - Indicator codes ..... 49
  
- P**
- Packing system ..... 169
- password
  - Device Manager ..... 34
  - iDRAC ..... 34
  - server ..... 34
- Pin assignment ..... 55
- Pins
  - Adapter cable ..... 57
  - Lynx CBL-AES1604 ..... 59
- Play after write ..... 32
- Playing content ..... 84
- Port
  - iDRAC Direct ..... 37
  - iDRAC8 Enterprise ..... 40
  - USB ..... 38, 40
  - USB management ..... 37
- Ports ..... 60
- Power button ..... 38
- Power source
  - Troubleshooting ..... 176
- Power supply unit ..... 40, 42
  - Indicator codes ..... 42
  - Replacing ..... 158
  - Troubleshooting ..... 176
- Protocols ..... 82
  
- R**
- Rear ..... 40
- Removing system cover ..... 156
- Replacing
  - Cooling fan ..... 163
  - Cooling fan assembly ..... 162
  - Hard drive or SSD ..... 160
  - Power supply unit ..... 158
  - USB memory key ..... 165
- Required reading ..... 18
- Rescue stick ..... 54
- Restoring system ..... 102
- RJ45
  - Connector ..... 56
  - Pins ..... 57
- RS-422 ..... 40, 57
  - Pins ..... 57
- RSI ..... 147
  - error messages ..... 149
  - logs ..... 149
  - troubleshooting ..... 149
- RSI installer ..... 147
  
- S**
- Safety ..... 7
  - Maintenance ..... 154
  - Transport ..... 168
  - Troubleshooting ..... 172
- Scope of delivery ..... 35
- SD ..... 22
- serial number ..... 33
- SFP+ ..... 41
- Shut down
  - Frozen operating system ..... 79
  - While running ..... 79
- SNMP Data Points ..... 106
- Software ..... 82
- Software service
  - Integrating ..... 78
- SSD
  - Replacing ..... 160
- Starting system ..... 76
- Static IP ..... 77
- STL ..... 23
- subtitles ..... 25, 92, 93

<b>System cover</b> .....	51
Install .....	156
Maintenance .....	156
<b>System identification button</b> .....	40
<b>System updates</b> .....	105
<b>Sytem cover</b>	
Remove .....	156

## T

<b>TCP</b> .....	60
<b>Timecode</b> .....	31
<b>Transforming content</b> .....	86
<b>Transport</b> .....	167
<b>Troubleshooting</b> .....	171
Cooling fan .....	177
Cooling problems .....	177
External connections .....	173
Internal USB key .....	178
Power source .....	176
Power supply unit .....	176
USB .....	175
Video subsystem .....	174
<b>Type plate</b> .....	33

## U

<b>UDP</b> .....	60
<b>UHD</b> .....	22
<b>Updates</b> .....	105
<b>USB</b>	
Troubleshooting .....	175, 178
<b>USB management port</b> .....	37
<b>USB memory key</b>	
Replace .....	165
<b>USB port</b> .....	38, 40

## V

<b>VBI</b> .....	23
<b>VDCP</b> .....	88
<b>VENICE UI</b> .....	83
<b>VGA</b>	
Pin assignment .....	57
<b>Video connector</b> .....	37, 40
Pin assignment .....	57
<b>Video I/O formats</b> .....	48
<b>Video settings</b> .....	90
<b>Video signal</b> .....	45
<b>Video subsystem</b>	
Troubleshooting .....	174

